

ONKYO®

HD DVD Player

DV-HD805

Instruction Manual

Thank you for purchasing an Onkyo HD DVD Player. Read this manual carefully before using your new HD DVD Player. A good understanding of its features and operation will allow you to achieve optimum performance and enjoyment.

Keep this manual for future reference.

Contents

Introduction.....2

Preparation.....15

Basic Playback29

HD DVD Playback33

Detailed Settings34

**Miscellaneous
Information.....42**



WARNING:

TO REDUCE THE RISK OF FIRE OR ELECTRIC SHOCK, DO NOT EXPOSE THIS APPARATUS TO RAIN OR MOISTURE.

CAUTION:

TO REDUCE THE RISK OF ELECTRIC SHOCK, DO NOT REMOVE COVER (OR BACK). NO USER-SERVICEABLE PARTS INSIDE. REFER SERVICING TO QUALIFIED SERVICE PERSONNEL.



WARNING
RISK OF ELECTRIC SHOCK
DO NOT OPEN

AVIS
RISQUE DE CHOC ELECTRIQUE
NE PAS OUVRIR



The lightning flash with arrowhead symbol, within an equilateral triangle, is intended to alert the user to the presence of uninsulated "dangerous voltage" within the product's enclosure that may be of sufficient magnitude to constitute a risk of electric shock to persons.



The exclamation point within an equilateral triangle is intended to alert the user to the presence of important operating and maintenance (servicing) instructions in the literature accompanying the appliance.

Important Safety Instructions



1. Read these instructions.
2. Keep these instructions.
3. Heed all warnings.
4. Follow all instructions.
5. Do not use this apparatus near water.
6. Clean only with dry cloth.
7. Do not block any ventilation openings. Install in accordance with the manufacturer's instructions.
8. Do not install near any heat sources such as radiators, heat registers, stoves, or other apparatus (including amplifiers) that produce heat.
9. Do not defeat the safety purpose of the polarized or grounding-type plug. A polarized plug has two blades with one wider than the other. A grounding type plug has two blades and a third grounding prong. The wide blade or the third prong are provided for your safety. If the provided plug does not fit into your outlet, consult an electrician for replacement of the obsolete outlet.
10. Protect the power cord from being walked on or pinched particularly at plugs, convenience receptacles, and the point where they exit from the apparatus.
11. Only use attachments/accessories specified by the manufacturer.
12. Use only with the cart, stand, tripod, bracket, or table specified by the manufacturer, or sold with the apparatus. When a cart is used, use caution when moving the cart/apparatus combination to avoid injury from tip-over.

PORTABLE CART WARNING
S3125A
13. Unplug this apparatus during lightning storms or when unused for long periods of time.
14. Refer all servicing to qualified service personnel. Servicing is required when the apparatus has been damaged in any way, such as power-supply cord or plug is damaged, liquid has been spilled or objects have fallen into the apparatus, the apparatus has been exposed to rain or moisture, does not operate normally, or has been dropped.
15. Damage Requiring Service
Unplug the apparatus from the wall outlet and refer servicing to qualified service personnel under the following conditions:
 - A. When the power-supply cord or plug is damaged,
 - B. If liquid has been spilled, or objects have fallen into the apparatus,
 - C. If the apparatus has been exposed to rain or water,
 - D. If the apparatus does not operate normally by following the operating instructions. Adjust only those controls that are covered by the operating instructions as an improper adjustment of other controls may result in damage and will often require extensive work by a qualified technician to restore the apparatus to its normal operation,
 - E. If the apparatus has been dropped or damaged in any way, and
 - F. When the apparatus exhibits a distinct change in performance this indicates a need for service.
16. Object and Liquid Entry
Never push objects of any kind into the apparatus through openings as they may touch dangerous voltage points or short-out parts that could result in a fire or electric shock.
The apparatus shall not be exposed to dripping or splashing and no objects filled with liquids, such as vases shall be placed on the apparatus.
Don't put candles or other burning objects on top of this unit.
17. Batteries
Always consider the environmental issues and follow local regulations when disposing of batteries.
18. If you install the apparatus in a built-in installation, such as a bookcase or rack, ensure that there is adequate ventilation.
Leave 20 cm (8") of free space at the top and sides and 10 cm (4") at the rear. The rear edge of the shelf or board above the apparatus shall be set 10 cm (4") away from the rear panel or wall, creating a flue-like gap for warm air to escape.

Precautions

- 1. Recording Copyright**—Unless it's for personal use only, recording copyrighted material is illegal without the permission of the copyright holder.
- 2. AC Fuse**—The AC fuse inside the unit is not user-serviceable. If you cannot turn on the unit, contact your Onkyo dealer.
- 3. Care**—Occasionally you should dust the unit all over with a soft cloth. For stubborn stains, use a soft cloth dampened with a weak solution of mild detergent and water. Dry the unit immediately afterwards with a clean cloth. Don't use abrasive cloths, thinners, alcohol, or other chemical solvents, because they may damage the finish or remove the panel lettering.
- 4. Power**
WARNING
BEFORE PLUGGING IN THE UNIT FOR THE FIRST TIME, READ THE FOLLOWING SECTION CAREFULLY.
AC outlet voltages vary from country to country. Make sure that the voltage in your area meets the voltage requirements printed on the unit's rear panel (e.g., AC 230 V, 50 Hz or AC 120 V, 60 Hz).
The power cord plug is used to disconnect this unit from the AC power source. Make sure that the plug is readily operable (easily accessible) at all times. Never disconnect the power cord from a wall outlet while the player is turned on, unless it is in an emergency. Doing so may cause malfunction. Pressing the [ON/STANDBY] button to select Standby mode does not fully shutdown the unit. If you do not intend to use the unit for an extended period, remove the power cord from the AC outlet.
- 5. Never Touch this Unit with Wet Hands**—Never handle this unit or its power cord while your hands are wet or damp. If water or any other liquid gets inside this unit, have it checked by your Onkyo dealer.
- 6. Handling Notes**
 - If you need to transport this unit, use the original packaging to pack it how it was when you originally bought it.
 - Do not use volatile liquids, such as insect spray, near the player. Do not leave rubber or plastic items on this unit for a long time, because they may leave marks on the case.
 - This unit's top and rear panels may get warm after prolonged use. This is normal.
 - If you do not use this unit for a long time, it may not work properly the next time you turn it on, so be sure to use it occasionally.
 - When you've finished using this unit, remove all discs and turn off the power.
- 7. Installing this Unit**
 - Before placing the player, make sure that the surface can stand the weight of the player.
 - Install this unit in a well-ventilated location.
 - Ensure that there's adequate ventilation all around this unit, especially if it's installed in an audio rack. If the ventilation is inadequate, the unit may overheat, leading to malfunction.
 - Do not expose this unit to direct sunlight or heat sources, because its internal temperature may rise, shortening the life of the optical pickup.
 - Avoid damp and dusty places, and places subject to vibrations from loudspeakers. Never put the unit on top of, or directly above a loudspeaker.
 - Install this unit horizontally. Never use it on its side or on a sloping surface, because it may cause a malfunction.
 - If you install this unit near a TV, radio, or VCR, the picture and sound quality may be affected. If this occurs, move this unit away from the TV, radio, or VCR.
 - Never place the player in a high location to avoid damage to the product or person by an accidental fall of the player.
- 8. To Obtain a Clear Picture**—This unit is a high-tech, precision device. If the lens on the optical pickup, or the disc drive mechanism becomes dirty or worn, the picture quality may be affected. To maintain the best picture quality, we recommend regular inspection and maintenance (cleaning or worn part replacement) every 1,000 hours of use depending on the operating environment. Contact your Onkyo dealer for details.
- 9. Moisture Condensation**
Moisture condensation may damage this unit.
Read the following carefully:
Moisture may condense on the lens of the optical pickup, one of the most important parts inside this unit.
 - Moisture condensation can occur in the following situations:
 - The unit is moved from a cold place to a warm place.
 - A heater is turned on, or cold air from an air conditioner is hitting the unit.
 - In the summer, when this unit is moved from an air conditioned room to a hot and humid place.
 - The unit is used in a humid place.
 - Do not use this unit when there's the possibility of moisture condensation occurring. Doing so may damage your discs and certain parts inside this unit. If condensation does occur, remove all discs and leave this unit turned on for two to three hours. By this time, the unit will have warmed up and any condensation will have evaporated.

Precautions (Continued)

10. Region Numbers—The DVD standard uses region numbers to control how discs can be played around the world, the world being divided into six regions. This unit will only play DVD discs that match its region number, which can be found on its rear panel (e.g., , ).

11. About this Manual—This manual explains how to use all of this unit's functions. Although the DVD standard offers many special features, not all discs use them all, so depending on the disc being played, this unit may not respond to certain functions. See the disc's sleeve notes for supported features.

This unit contains a semiconductor laser system and is classified as a "CLASS 1 LASER PRODUCT". So, to use this model properly, read this Instruction Manual carefully. In case of any trouble, please contact the store where you purchased the unit.

To prevent being exposed to the laser beam, do not try to open the enclosure.

CAUTION:

CLASS 1M VISIBLE AND INVISIBLE LASER RADIATION WHEN OPEN. DO NOT VIEW DIRECTLY WITH OPTICAL INSTRUMENTS.

THIS PRODUCT UTILIZES A LASER. USE OF CONTROLS OR ADJUSTMENTS OR PERFORMANCE OF PROCEDURES OTHER THAN THOSE SPECIFIED HEREIN MAY RESULT IN HAZARDOUS RADIATION EXPOSURE.

The label on the right is applied on the rear panel.

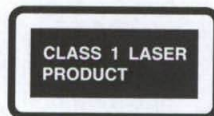

1. This unit is a CLASS 1 LASER PRODUCT and employs a laser inside the cabinet.
2. To prevent the laser from being exposed, do not remove the cover. Refer servicing to qualified personnel.

WARNING

To prevent a fire hazard, do not place any naked flame sources (such as a lighted candle) on the equipment.

When disposing of used batteries, please comply with governmental regulations or environmental public instruction's rules that apply in your country/area.

For U.S. models

FCC Information for User

CAUTION:

The user changes or modifications not expressly approved by the party responsible for compliance could void the user's authority to operate the equipment.

NOTE:

This equipment has been tested and found to comply with the limits for a Class B digital device, pursuant to Part 15 of the FCC Rules. These limits are designed to provide reasonable protection against harmful interference in a residential installation.

This equipment generates, uses and can radiate radio frequency energy and, if not installed and used in accordance with the instructions, may cause harmful interference to radio communications. However, there is no guarantee that interference will not occur in a particular installation. If this equipment does cause harmful interference to radio or television reception, which can be determined by turning the equipment off and on, the user is encouraged to try to correct the interference by one or more of the following measures:

- Reorient or relocate the receiving antenna.
- Increase the separation between the equipment and receiver.
- Connect the equipment into an outlet on a circuit different from that to which the receiver is connected.
- Consult the dealer or an experienced radio/TV technician for help.

For Canadian Models

NOTE: THIS CLASS B DIGITAL APPARATUS COMPLIES WITH CANADIAN ICES-003.

For models having a power cord with a polarized plug:
CAUTION: TO PREVENT ELECTRIC SHOCK, MATCH WIDE BLADE OF PLUG TO WIDE SLOT, FULLY INSERT.

Modèle pour les Canadien

REMARQUE: CET APPAREIL NUMÉRIQUE DE LA CLASSE B EST CONFORME À LA NORME NMB-003 DU CANADA.

Sur les modeles dont la fiche est polarisée:

ATTENTION: POUR ÉVITER LES CHOCS ÉLECTRIQUES, INTRODUIRE LA LAME LA PLUS LARGE DE LA FICHE DANS LA BORNE CORRESPONDANTE DE LA PRISE ET POUSSER JUSQU'AU FOND.

For British models

Replacement and mounting of an AC plug on the power supply cord of this unit should be performed only by qualified service personnel.

IMPORTANT

The wires in the mains lead are coloured in accordance with the following code:

Blue: Neutral
Brown: Live

As the colours of the wires in the mains lead of this apparatus may not correspond with the coloured markings identifying the terminals in your plug, proceed as follows: The wire which is coloured blue must be connected to the terminal which is marked with the letter N or coloured black.

The wire which is coloured brown must be connected to the terminal which is marked with the letter L or coloured red.

IMPORTANT

The plug is fitted with an appropriate fuse. If the fuse needs to be replaced, the replacement fuse must be approved by ASTA or BSI to BS1362 and have the same ampere rating as that indicated on the plug. Check for the ASTA mark or the BSI mark on the body of the fuse. If the power cord's plug is not suitable for your socket outlets, cut it off and fit a suitable plug. Fit a suitable fuse in the plug.

For European Models

Declaration of Conformity

We, ONKYO EUROPE
ELECTRONICS GmbH
LIEGNITZERSTRASSE 6,
82194 GROEBENZELL,
GERMANY



declare in own responsibility, that the ONKYO product described in this instruction manual is in compliance with the corresponding technical standards such as EN60065, EN55013, EN55020 and EN61000-3-2, -3-3.

GROEBENZELL, GERMANY

K. MIYAGI

ONKYO EUROPE ELECTRONICS GmbH

Notes on copyright

- The unauthorized recording, use, display, distribution, or revision of television programs, videotapes, HD DVDs, DVDs, CDs and other materials, is prohibited under the Copyright Laws of the United States and other countries, and may subject you to civil and/or criminal liability.
- This product incorporates copyright protection technology that is protected by method claims of certain U.S. patents and other intellectual property rights owned by Macrovision Corporation and other rights owners. Use of this copyright protection technology must be authorized by Macrovision Corporation, and is intended for home and other limited viewing uses only unless otherwise authorized by Macrovision Corporation. Reverse engineering or disassembly is prohibited.



Dolby and the double-D symbol are registered trademarks of Dolby Laboratories.



Manufactured under license from DTS, Inc. under one or more of the following U.S. Pat. No's: 5,451,942; 5,956,674; 5,974,380; 5,978,762; 6,226,616; 6,487,535 and other U.S. and world-wide patents issued and pending. "DTS" is a registered trademark of DTS, Inc. and "DTS-HD Advanced Digital Out" is a trademark of DTS, Inc. Copyright 1996, 2002-2006 DTS, Inc. All Rights Reserved.



HDMI, the HDMI logo and High-Definition Multimedia Interface are trademarks or registered trademarks of HDMI Licensing LLC.



SHARC and Melody are registered trademarks of Analog Devices, Inc.



VRS is a trademark of Anchor Bay Technologies, Inc.

HD DVD and **DVD** are trademarks of DVD Format/Logo Licensing Corporation.

All other brand and product names mentioned in this manual are trademarks and/or registered trademarks of their respective holders.

Table of contents







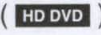

Important Safety Instructions	2	Customizing the function settings	35
Precautions	3	Settings	36
Features	7	Picture	36
Disc compatibility.....	7	Audio	37
Customer support.....	9	Language	38
Index to parts and controls	10	Ethernet	40
Accessories	12	General	40
Remote control	12	Firmware update	41
Loading batteries.....	12	Before calling service personnel	42
TV control.....	13	License information on the software used	
Preparation	15	in the Onkyo HD DVD player	43
Resolution and connections	15	Specification	50
Step 1: Connecting to a TV	16		
Step 2: Connecting to audio system.....	17		
Step 3: LAN connection.....	19		
Step 4: Power connection	20		
Step 5: Powering on.....	20		
Step 6: Setting up the player	21		
A: Language.....	21		
B: Time.....	22		
C: Resolution.....	23		
D: Audio output	25		
E: Ethernet	27		
Playing	29		
Playing a disc	29		
To pause playback.....	30		
To stop playback	30		
To resume playback from the location			
last stopped.....	30		
Basic operations table.....	30		
To select the sound	31		
To select subtitles	31		
To select the camera angle.....	31		
To locate a position	32		
To play repeatedly.....	32		
To check the current status.....	32		
HD DVD playing options in the future.....	33		
A/B/C/D buttons	33		
Cursor controls.....	33		
Controller port	33		
Requirements for HD DVD discs/			
Web-enabled network content	33		
Output sound conversion table	34		

Features

Disc compatibility

Discs which can be played on this player are as follows.

The icons () are used in this manual to indicate features and/or functions that are applicable to various types of discs.

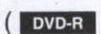
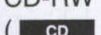
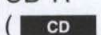
Disc	Specification		
Prerecorded discs			
HD DVD video disc  	12cm (4 ³ / ₄ in.) HD DVD video discs are high-density, high-capacity discs. <ul style="list-style-type: none"> The HD DVD disc standard has been approved by the DVD forum. HD DVD (single layer): 15 GB HD DVD (dual layer): Maximum capacity of 30 GB A single layer single sided disc (15 GB) has capacity of about 8 hours in 1125 line high definition picture; about 48 hours in 525 line standard definition picture (depending on bitrate of pre-recorded contents). *1GB means 1,000,000,000 bytes. HD DVD Twin Format Discs have both HD DVD and DVD layers on one side. HD DVD Combination Format Discs have HD DVD material on one side and DVD material on the other side. 		
DVD video disc  	12cm (4 ³ / ₄ in.) / 8cm (3 ¹ / ₄ in.) See page 8 for region information.		
Audio CD  	12cm (4 ³ / ₄ in.) / 8cm (3 ¹ / ₄ in.)		
Recordable discs			
DVD-RW  	DVD VR mode recording (CPRM compatible discs not supported.) DVD Video mode recording Finalized discs only.	DVD-R  	DVD VR mode recording (CPRM compatible discs not supported.) DVD Video mode recording Finalized discs only.
CD-RW 	CD-DA (audio CD) format Finalized discs only.	CD-R 	CD-DA (audio CD) format Finalized discs only.

Notes

- North American models can play pictures of the NTSC color system only: European models can play pictures of the PAL/NTSC color system only.
- You cannot play non-standardized discs even if they may be labeled as above.
- Discs other than the above cannot be played. Even some of the above discs may not be able to be played depending on their state.
- Blu-ray Discs cannot be played on this player.

Notes on handling discs

- Do not touch the playback side of the disc.
- Do not stick paper or tape to discs.
- Fingerprints and dust on the disc may cause picture and/or sound deterioration or prevent playback. Wipe the disc from the centre outwards with a soft cloth. Always keep the disc clean.
- Do not use any type of solvent such as thinner, benzene, commercially available cleaners or antistatic spray for vinyl LPs. It may damage the disc.
- Refer to the instructions of the disc as well.
- Do not store discs in a place subject to direct sunlight or near heat sources.
- Do not store discs in places subject to moisture and dust such as a bathroom or near a humidifier.
- Store discs vertically in a case. Stacking or placing objects on discs outside of their case may cause warping.

Features (Continued)

Important notes about HD DVD

HD DVD with high-definition content required for HD viewing. Viewing high-definition content and up-converting DVD content may require an HDCP capable DVI or HDMI input on your 50/60 Hz display device. Up-conversion of DVD content will result in near HD picture quality. Firmware update may be required for some interactive features depending on content, which may also require an always-on broadband internet connection. Some features may require additional bandwidth. Some recordable media may not be supported. Dolby Digital Plus, Dolby TrueHD and DTS support for up to 5.1 channels (DTS HD support for DTS core only). MP3/WMA audio files not supported. Because HD DVD is a new format that makes use of new technologies, certain disc, digital connection and other compatibility and/or performance issues are possible. This may, in rare cases, include disc freezing while accessing certain disc features, or functions, or certain parts of the disc not playing back or operating as fully intended. If you experience such issues, please contact your Onkyo dealer. Some features subject to delayed availability. 1080p capable display required for 1080p output resolution. Deep Color feature as specified in HDMI 1.3a requires compatible Deep Color capable HD display and/or device. For 24p output, content that was created in 1080p / 24 frames/sec is required. Viewing 24p output requires an HD display capable of accepting a 1080p/24Hz signal. While every effort has been made at the time of publication to ensure the accuracy of the information provided herein, product specifications, configurations, system/component/options availability are all subject to change without notice.

Note

- The firmware in this player can be updated. See ⇒ page 41 for details.

DVD-Video regions

All DVD-Video discs carry a region mark on the case somewhere that indicates which region(s) of the world the disc is compatible with. Your HD DVD player also has a region mark, which you can find on the rear panel. Discs from incompatible regions will not play in this player. In this case the attention sentence "Incompatible disc region number Can't play disc" is displayed on screen. Discs marked "ALL" will play in any player. The diagram below shows the various DVD regions of the world.

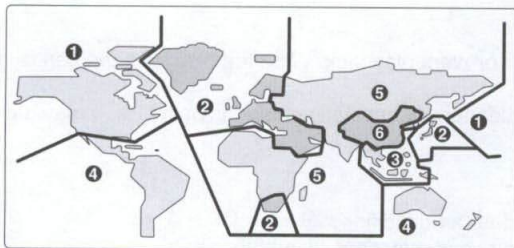

About the volume level

The volume level of some commercial HD DVD and DVD discs may seem lower than that of audio CDs, other software, etc. If you turn up the volume of the TV or amplifier to play such discs, be sure to turn it back down after playback finishes.

Playback restrictions

This owner's manual explains the basic instructions for this player. Some HD DVD discs or DVD video discs are produced in a manner that allows specific or limited operation during playback. As such, the player may not respond to all operating commands. This is not a defect in the player. Please refer to the notes on compatible discs later in this Introduction and to the discussion of DVD playback and features later in this manual.

"⊗" may appear on the TV screen during operation. "⊗" means that the operation is not permitted by the player or the disc.

About software

Because of problems and errors that can occur during the creation of HD DVD, DVD and CD software and/or the manufacture of HD DVD, DVD and CD discs, Onkyo cannot assure that this player will successfully play every disc bearing the HD DVD, DVD or CD logos. If you happen to experience any difficulty playing an HD DVD, DVD or CD disc on this player, please contact your Onkyo dealer.

Some differences

The HD DVD player operates more like a computer and differently than a standard DVD player. In addition to containing a microprocessor, it contains an operating system, random access memory (RAM), and an HD DVD drive. The operating system includes software that is transferred to the RAM when the machine is turned on and at other times during operation. This transfer can take time. Therefore, when you turn the HD DVD player on, it may take a little while before it is ready to use. Likewise, other functions may not be performed as quickly as they would on other AV equipment. Please take these factors into consideration as you use the HD DVD player.

Notes on web-enabled network content

Certain HD DVD discs may contain or have the capability of downloading studio-provided, web-enabled network content. To minimize any potential compatibility and/or connectivity issues, before viewing such content, it is recommended that you perform the firmware update process to ensure that your HD DVD player is using the latest firmware version. Do not unplug or turn off the HD DVD player when downloading studio-provided, web-enabled network content. Doing so may cause data stored in the player's persistent storage to be lost.

HD output jacks

- An HDMI jack for connecting a single cable to output video and audio signals
- Component jacks
- 5.1 channel surround analog audio jacks

Certain system requirements

For high definition video playback:

- 50/60 Hz compatible HD display (some discs may require HDCP capable input)
- HD DVD disc with HD content

For Dolby® Digital Plus and Dolby TrueHD multi-channel audio playback:

- A/V Receiver with HDMI™ multi-channel LPCM capable audio input and 5.1 channel speaker setup.

Customer support

Please contact your Onkyo dealer.

Before accessing, try updating this player's firmware. For details on how to update, see "Update (Firmware update)" (⇒ page 41).

This HD DVD player is manufactured under the HD DVD Format adopted by the DVD Forum. The DVD Forum approved AACS (Advance Access Content System) as content protection system for HD DVD format like it approved CSS (Content Scramble System) for DVD format. Therefore, certain restrictions are imposed on play, analog signal output, etc. of AACS protected contents. When you use pre-recorded contents, the contents may designate whether or not to apply such restrictions. As those restrictions may be adopted and/or changed and announced by AACS after the production of this product, the operation of this product and restrictions thereon may vary depending on the time you purchase this product as well as during the life of this product. To obtain updated information about AACS and this product, please contact your Onkyo dealer.

Index to parts and controls

Front panel

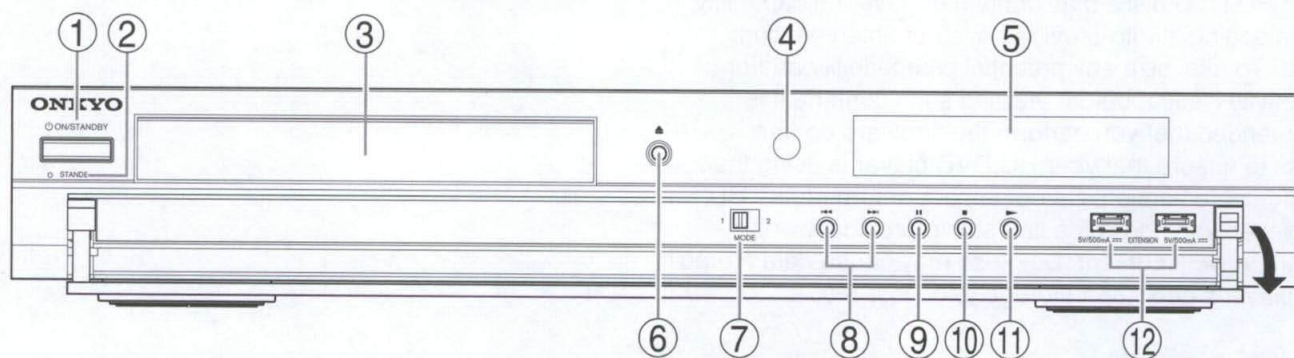

* The above illustration displays the front panel with the cover open.

No.	Control	Function	Page
①	ON/STANDBY button	Turns the power on or restores the unit to the standby mode.	20
②	STANDBY indicator	Blue: power on / Red: standby mode	20
③	Disc tray	Loads a disc into the disc drive.	29
④	Remote sensor	Receives infrared signals from the remote control.	12
⑤	Front panel display	See the next page.	11
⑥	▲ (OPEN/CLOSE) button	Opens and closes the disc tray.	29
⑦	MODE switch	Selects the video output jack.	15
⑧	⏮ / ⏭ (SKIP) buttons	Locates a chapter or track. ⏭: forward direction / ⏮: reverse direction	30
⑨	⏸ (PAUSE) button	Stops playback momentarily.	30
⑩	■ (STOP) button	Stops playback.	30
⑪	▶ (PLAY) button	Starts playback.	29
⑫	EXTENSION port	For future functions.	33

Rear panel

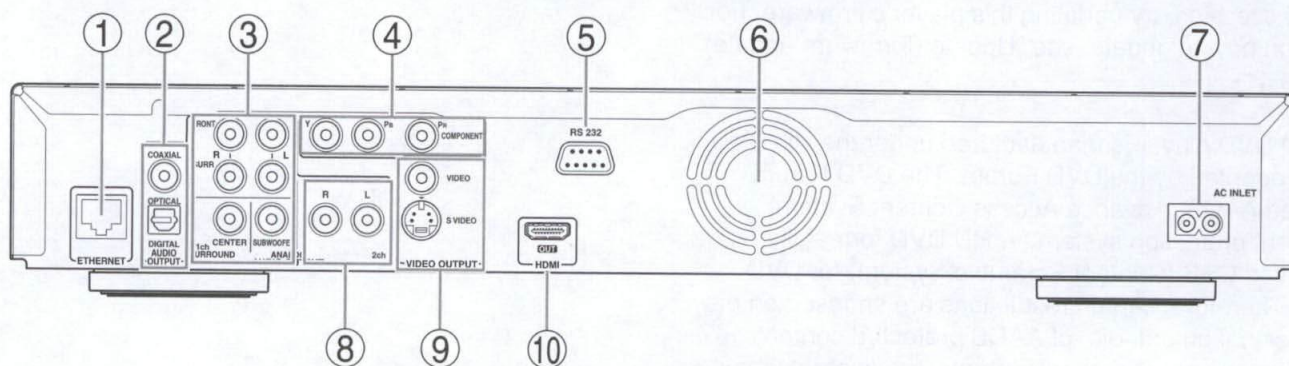

No.	Control	Function	Page
①	ETHERNET port	Use this to connect to a network with an always-on broadband connection.	19
②	DIGITAL AUDIO OUTPUT OPTICAL/COAXIAL jack	Outputs digital audio signals. Connect to a digital audio input on an amplifier equipped with digital audio decoder. When connecting the optional digital cable, fit the connector into the jack firmly.	17
③	ANALOG AUDIO OUTPUT 5.1ch SURROUND jacks	Outputs analog audio signals. Connect to an amplifier equipped with 5.1 channel audio input.	18
④	COMPONENT VIDEO OUTPUT jacks	Outputs video signals to a connected TV or monitor. Connect to a TV or monitor equipped with component video jacks.	16
⑤	RS-232 jack	Used for custom control devices.	—
⑥	Ventilation fan	Do not cover the ventilation holes.	—
⑦	AC INLET socket	Connect the supplied power cord.	20
⑧	ANALOG AUDIO OUTPUT 2ch jacks	Outputs audio signals to a connected TV or AV amplifier.	18
⑨	VIDEO OUTPUT (VIDEO, S VIDEO) jack	Outputs video signals to a connected TV or amplifier.	17
⑩	HDMI OUT jack	Outputs video/audio signals to a connected TV, monitor or AV amplifier. Connect to a TV, monitor or AV amplifier equipped with HDMI input.	16

Display

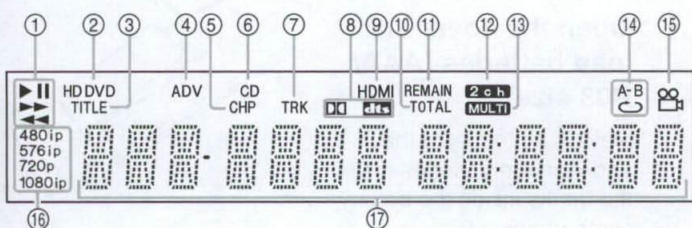

No.	Function
①	▶ : Playing
	⏸ : Pausing
	⏩ : Fast forward playback
	⏪ : Fast reverse playback
②	HD DVD: An HD DVD is loaded. DVD: A DVD is loaded.
③	Shows a title number.
④	A disc which contains advanced content is loaded.
⑤	Shows a chapter number.
⑥	A CD is loaded.

No.	Function
⑦	Shows a track number.
⑧	: Dolby Digital sound is played.
	: DTS sound is played.
⑨	HDMI connection is verified between the player and another device.
⑩	Total playing time is displayed.
⑪	Remaining playing time is displayed.
⑫	2ch sound is output.
⑬	Multi channel sound is output.
⑭	Playing in repeat mode.
⑮	Playing a scene recorded with multi angles.
⑯	Displays the video output format currently selected. (i: interlaced, p: progressive)
⑰	Displays the elapsed time, remaining time, a number of title, chapter or track, messages, etc.

Pressing DIMMER button on the remote control changes the brightness of the display. (Normal / dimmed / off)
 • Turning off the power resets this setting.

Remote control

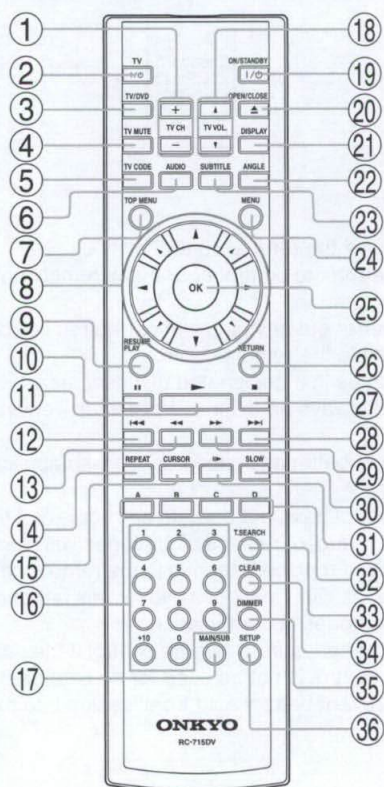

No.	Function	Page
①	To change TV channels.	13
②	To turn the TV on or off.	13
③	To change inputs of the TV.	13
④	To mute the TV.	13
⑤	To program the remote control to control a TV.	13
⑥	To select the sound.	31
⑦	To display a top menu.	29
⑧	To select a content or position to enter.	21, 29

No.	Function	Page
⑨	To resume playback while playing an HD DVD.	30
⑩	To pause playback.	30
⑪	To start playback.	29
⑫	To locate a title, chapter or track in the reverse direction.	30
⑬	To play fast in reverse direction.	30
⑭	To display a repeat mode menu.	32
⑮	To set the 8 direction buttons to move the cursor during HD DVD playback.	33
⑯	To enter numbers.	32
⑰	For future functions which may become available by software update.	-
⑱	To adjust TV volume.	13
⑲	To turn the power on or off.	20
⑳	To open/close the disc tray.	29
㉑	To display operating status.	32
㉒	To select a camera angle.	31
㉓	To display subtitles.	31
㉔	To display a menu included on many DVD video discs.	29
㉕	To enter a selected content.	21, 29
㉖	To return to the previous menu.	21
㉗	To stop playback.	30
㉘	To locate a title, chapter or track in the forward direction.	30
㉙	To play fast in forward direction.	30
㉚	To play in slow motion.	30
㉛	To play frame by frame.	30
㉜	To operate as indicated by the video display during HD DVD playback.	33
㉝	To display a window to locate a title, chapter or track.	32
㉞	To clear entered information.	32
㉟	To change the brightness of the display on the player.	11
㊱	To display the setup menu.	35

Accessories

Supplied accessories

Check that the following accessories are supplied.

Remote control
Batteries
(AAA/R03)×2

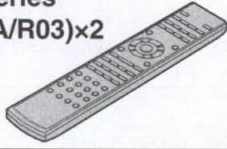

Composite audio/video
cable

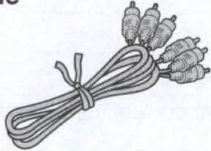

Power cord
For North American Models

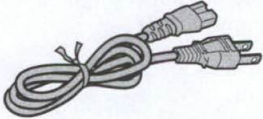

For European Models

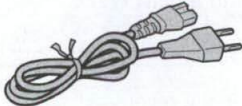

Caution

- Do not use this power cord with any device other than this player.

* In catalogs and on packaging, the letter at the end of the product name indicates the color. Specifications and operations are the same regardless of color.

Remote control

Loading batteries

- 1 **Open the cover and load batteries (AAA/R03 size).**

Make sure to match the + and - on the batteries to the marks inside the battery compartment.

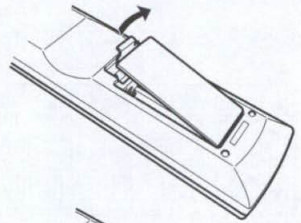

- 2 **Close the cover.**

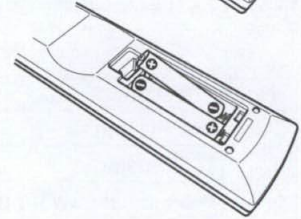

Operating range

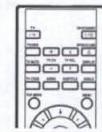
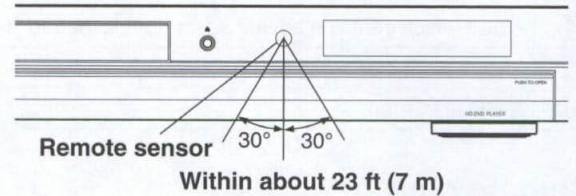

Notes

- Do not drop or give the remote control a shock.
- Do not leave the remote control near an extremely hot or humid place.
- Do not spill water or put anything wet on the remote control.
- Do not disassemble the remote control.
- Dispose of batteries in a designated disposal area.
- Batteries should always be disposed of with the environment in mind.
- Always dispose of batteries in accordance with applicable laws and regulations.
- If the remote control does not operate correctly, or if the operating range becomes reduced, replace all batteries with new ones.
- When necessary to replace batteries in the remote control, always replace all batteries with new ones. Never mix battery types or use new and used batteries in combination.
- Always remove batteries from remote control if they are dead or if the remote control is not be used for an extended period of time. This will prevent battery acid from leaking into the battery compartment.

Caution

Never throw batteries into a fire.

TV control

The remote control of this player is compatible with TV controls.

Once you program the remote control (see the next paragraph), the following controls are available. Operate the remote control toward your TV.

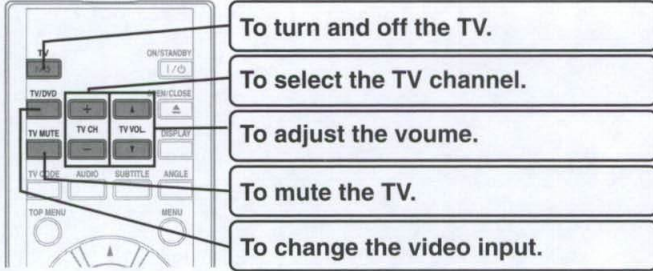

To program the remote control to operate your TV

- 1 While holding TV CODE, press the number buttons to enter a corresponding brand code (see below) of your TV.

Some brands have several codes. Try one by one until the remote control can operate your TV.

- 2 Release TV CODE.

The brand code is memorized.

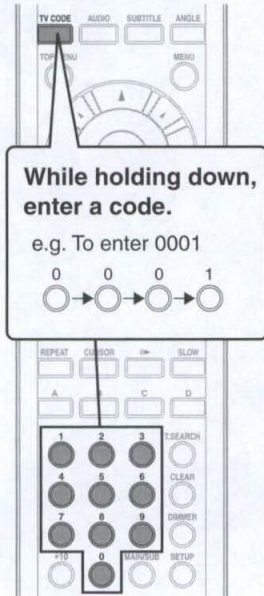

Note

- When replacing the batteries of the remote control, re-enter the brand code of your TV.

For North American Models

Brand name	Brand code
Bell & Howell	0081 0431
Citizen	0051 0381 0471 0551 0621 0851 1561
Curtis Mathes	0051 0391 0431 0531 0621 0851 1521 1561
Emerson	0051 0111 0121 0141 0151 0161 0201 0211 0351 0381 0431 0521 0561 0571 0621 0691 1241 1291 1371 1561 2481 4871
Fisher	0251 0401 0431 1151 2451 2461
GE	0001 0041 0051 0091 0181 0321 0371 0391 0591 0621 0711 0741 1041 1471 1521 2481 4691 4881 4891
Goldstar	0051 0061 0161 0231 0451 0501 0621 0661 0771 0961 1431 1561 2491
Hitachi	0031 0051 0161 0191 0301 0601 0621 0641 0671 0811 0821 0951 1011 1061 1241 1361 1651 1711 1731 1741 1751 1761 2041 2051 2131 2381 4121 4731 4901 4911 4921 4931 4941 4951 4961 5631
Infinity	0631
JBL	0631
JVC	0101 0161 0191 0241 0331 0511 0561 0601 0741 0991 1321 1421 2161 2171 4341 4351 4701 4711 4721 4741 4751 4761 4771 4781 4791 4801 4811 4971 4981 4991 5001 5011 5021 5031 5041 5051 5061 5071 5081 5091 5101 5111 5121 5131 5141 5151 5161 5171 5181 5191 5201
LXI	0311 0391 0411 0431 0621 0631 0881 1041 1171 1521 2491

Brand name	Brand code
Maganvox	0051 0271 0291 0341 0361 0421 0551 0621 0631 0661 0971 0981 1131 2221 5221 5231 5241
Marantz	0051 0481 0621 0631 0641 2491
Memorex	0081 0431 0501 0621 2491 4421 5251
MGA	0051 0251 0261 0371 0501 0621 0661 0761
Mitsubishi	0051 0251 0261 0281 0371 0491 0501 0621 0661 0761 2231 2241 5261 5271
MTC	0051 0501 0621 0851
NAD	0311 0411 0621 0881 1061
Optonica	0541 1101
Panasonic	0631 0711 0741 1271 1351 1401 1501 1701 1791 1801 2111 2151 2301 2321 4101 5281 5291 5301 5311 5321 5331 5341 5351 5361 5371 5381 5391 5661
Philco	0051 0161 0271 0291 0361 0421 0501 0551 0621 0631 0661 0711
Philips	0051 0161 0271 0321 0361 0421 0461 0551 0631 0661 0711 2141 2351 5401 5411 5421 5431 5451 5461 5471 5481 5491 5501 5531 5541 5551 5601 5621
Pioneer	0051 0621 0681 0721 0751 1061 1241 1581 1971 4081 4111
Proton	0051 0161 0621 0651 2491
Quasar	0711 0741 0801 1401 2281 5651 5661
Radio Shack	0431 1521 2481
Radio Shack/Realistic	0051 0161 0381 0391 0431 0541 0621 1431 1561
RCA	6641 0001 0051 0221 0391 0501 0621 0661 0711 0871 0911 0921 0941 1001 1041 1071 1091 1181 1211 1241 1301 1461 1491 1521 1531 2291 2481 4361 5671 5681 5691 5701 5711 5721
Realistic	0431 1521
Runco	0011
Samsung	0051 0161 0501 0531 0621 0661 0851 0931 1021 1141 1431 1561 1591 1601 1771 1811 1821 1831 1841 1851 1861 1931 2081 2101 2311 4011 4061 5731
Sanyo	0051 0261 0401 0431 0791 0901 1151 2461
Sears	0051 0151 0191 0251 0311 0331 0391 0401 0411 0431 0621 0661 0881 1041 1081 1151 1481 1521 2461 2481
Sharp	0051 0111 0161 0351 0541 0581 0611 0621 0731 0891 1101 1561 1721 1871 1881 1941 2181 2341 5741 5751 5761 5771
Sony	0441 1111 1231 1511 2401 2411 2431 1891 1901 2061 2421 5781 5791 5801 5811 5821 5831 5841 5851 5861 5871 5881 5891 5901 5911
Soundesign	0051 0151 0381 0551 0621 2481
Sylvania	0051 0071 0271 0291 0341 0361 0421 0551 0621 0631 0661 0861 1441 2191 2201 4151 4441 5921 5931
Tandy	1101
Technics	0741
Teknika	0051 0081 0151 0161 0191 0341 0381 0471 0501 0551 0621 0851 1271 1401 1561 2481
Toshiba	0001 0021 0071 0411 0431 0831 0841 0851 0881 1341 1611 1621 1681 1781 1951 2121 2461 2491 4071 4371 5951 5971 6041 6101 6111 6121 6131 6141
Wards	0051 0081 0141 0151 0181 0211 0271 0321 0341 0361 0391 0421 0501 0541 0621 0631 0661 1051 1521 2491
Zenith	0011 0051 0081 0781 1281 1571 2091 2211 2251 2361 2391 2441 4821 4831 4841 4851 6151 6161 6171 6181

Remote control (Continued)

For European Models

Brand name	Brand code
Aiwa	3241
Akai	2671
Bang & Olufsen	2621
Beko	2941 3331 4471
Blaupunkt	2711 2801
Brionvega	2621
Bush	2541 2681 2691 2751 2781 2851 2861 2881 3291 4261 4481
Crown	2541 2871 2921
Daewoo	2541 2881 3221 3271
Decca	2611
Ferguson	2761 2841 3351
Finlux	2601 2611 2621
Fisher	2671 2981
Funai	2731 2781
GEC	2591 2611
Goodmans	2611 2691 2861 2881 3221 3841
Granada	2611 2671
Grundig	2601 2701 3151 3441 4491
Hinari	2541 2681 2691 2901
Hitachi	2591 3301 3471 3501 3511 3701 3671 4501
Inno Hit	2611
JVC	2861 3361 3591 4511
LG Goldstar	2491
Loewe	2621 2771 2961 3311
Luxor	2701
Marantz	2991
Matsui	2541 2581 2611 2651 2671 2691 2781 2851 2861 3151
Metz	2621
Mitsubishi	2621 2701 2961 3371 4521
National	2701
Orion	2691 2781 2851 3381
Panasonic	2701 2711 2741 3001 3251 3531 3551 3761 3911 3951
Philco	2621
Philips	2561 2571 2591 2621 2811 2821 2881 2991 3461 3581 3731 3881 3981 4531 4541 4551
Pioneer	2761 3481 3681 3921 3931 3941
Saba	2621 2761 2841 3321
Saisho	2541 2651 2691 2731
Samsung	2541 2631 2731 2991 3161 3231 3521 3541 3711 3721 3901 3961 4271 4561
Sanyo	2611 2671 3391
Schneider	2571 2681 2811 2861 3991 4571 4581 4591 4601 4611
SEG	2731 3051
Seleco	2661 2721
Sharp	2641 3401 3611 3631 3781 3791 3801 3811 3821 3831 3971
Singer	2621
Sinudyne	2551 2621 2651 2691 3011 3051
Sony	2551 2951 3621 3641 3651 3871 3891 4281 4621
Tatung	2611
Technics	2711 3001
Telefunken	2841 3421
Tensai	2681 2781
Thomson	6641 2701 2761 2831 3431 3601 4631 4641 4651 4661
Thorn	2581 2611 2951 2961 3221
Toshiba	2581 2601 3281 3491 3771 4291 4301 4311 4321 4671
Universum	2731
Zanussi	2661

Preparation

Proceed the following steps to set the player ready.

Step 1: Connecting to a TV

Page 16

Step 2: Connecting to audio system

Page 17

Step 3: LAN connection

Page 19

Step 4: Power connection

Page 20

Step 5: Powering on

Page 20

Step 6: Setting up the player

Page 21

Resolution and connections

Check the type of video input on your TV. To view high definition content, use the HDMI OUT jack or the COMPONENT VIDEO OUTPUT jacks to connect to a TV. Some discs may require use of the HDMI OUT jack. Set the **MODE** switch according to your connection.

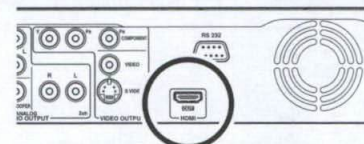

HDMI OUT jack

TV input	High definition video	MODE switch on the player Incorrect setting may disable the player's output.	Page
<p>HDMI input</p> <p>Most recommended*</p>	<p>Viewable. To view 1080p output, make this connection.</p>	<p>Open the cover.</p> <p>Be sure to set while the power is off.</p>	16
<p>Component video input</p>	<p>Viewable. (Some discs may be down converted or require HDMI connection.) Not compatible with 1080p. To view 1080p output, select HDMI connection.</p>	<p>Open the cover.</p> <p>Be sure to set while the power is off.</p>	16
<p>S-VIDEO or VIDEO (yellow) input</p>	<p>Down converted. (Some discs may require HDMI connection.)</p>	<p>Open the cover.</p> <p>Be sure to set while the power is off.</p>	17

*Why HDMI connection is most recommended?

HD DVD and DVD video disc creators have the option to include copy protection instructions in their discs that prohibit the output of some standard video or high definition video (original 720p, 1080i or 1080p or up-converted 480i (480i/576i) or 480p (480p/576p)) from the COMPONENT VIDEO OUTPUT jacks. If such instructions are present in the disc you are playing, you must use the HDMI OUT jack to view the disc in a high definition format and the COMPONENT VIDEO OUTPUT jacks, if activated, will output video only in 480i (480i/576i) or 480p (480p/576p) resolution.

Preparation (Continued)

Step 1: Connecting to a TV

- Connect the player directly to your TV. If you connect the player to a VCR, TV/VCR combination, video selector or AV amplifier, the playback picture may be distorted due to copy protection.
- Be sure to turn off the power and unplug both units from the wall outlet before making any connections.

Via HDMI input

To view 1080p output, make this connection.

HDMI transfers digital audio and uncompressed digital video on a single cable. As a result, audio cables and video cables don't need to be connected separately to a device.

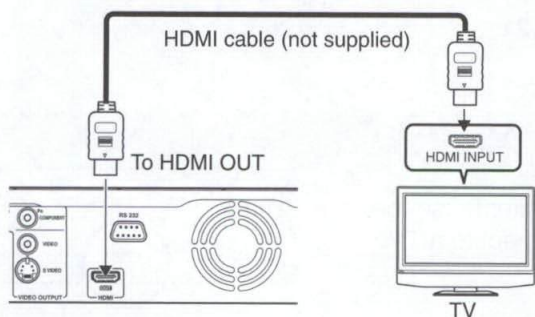

Notes

- When the HDMI connection is not verified, an error message appears on the front panel display. In this case, disconnect the HDMI cable then connect it again, or turn off the connected HDMI device then turn it on.
- HDMI output is digital only, DVI analog is not supported.
- HDMI is an evolving technology, so it is possible that some devices may not operate properly with this player.
- To get the most possible benefit from Dolby Digital Plus, you should connect your HD DVD player to your AV receiver using its HDMI input. If your AV receiver has this type of input, make sure it is connected to your HD DVD player and that the input is set to use audio from HDMI (and not the SPDIF coaxial or optical input). If your AV receiver does not have an HDMI input, then the next best choice is to use the SPDIF (coaxial or optical) input on your AV receiver.
- If you use the SPDIF (coaxial or optical) output or analog outputs to connect your audio system and have the "Digital Out HDMI" (⇒ page 25) set to "Auto" or "PCM", the audio output level from these jacks will be reduced when listening to a multichannel disc. To restore the audio output level, set "Digital Out HDMI" to "Downmixed PCM".
- Be sure to confirm compatibility of a cable when connecting a Deep Color compatible display device. When the output resolution (⇒ page 23) is set to "up to 1080p/24Hz", Deep Color output is disabled.

Via component video input

Some discs may be down converted or require HDMI connection. Not compatible with 1080p. To view 1080p output, select HDMI connection.

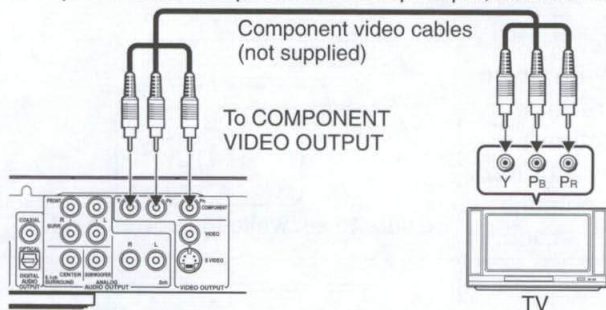

This connection only sends video signals. Be sure to make audio connection on ⇒ page 17.

Note

- This player supports simultaneous output of video on its HDMI and component video ports. However, some discs may restrict output of video on the component video ports when viewing high definition content or up-converted DVD content. The resolution on the HDMI output will be the same as the resolution output on the component video output. Thus, because the HDMI output can change automatically to match the maximum available resolution of your display, if you connect both the HDMI output and component output, the resolution on the component output will change if the HDMI output auto-adjusts.

Via S VIDEO or VIDEO (yellow) input

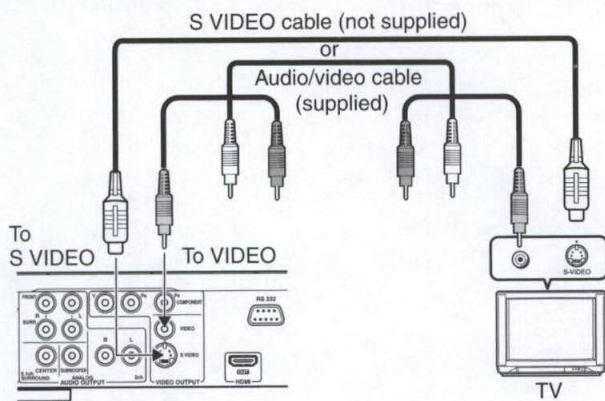

480i (480i/576i) output only regardless of the resolution settings (⇒ page 23) or the connections of other output jack.

This connection only sends video signals. Be sure to make audio connection on ⇒ page 17.

Step 2: Connecting to audio system

Sound can output from connected audio system.

If you made the HDMI connection between the player and a TV, this step is unnecessary. Skip to Step 3.

Via HDMI output

You can enjoy the benefits of Dolby Digital Plus or Dolby TrueHD by connecting the HDMI OUT jack of your player to an AV receiver with an HDMI audio input.

This connection requires selection of "Digital Out HDMI" (Step 16, ⇒ page 25).

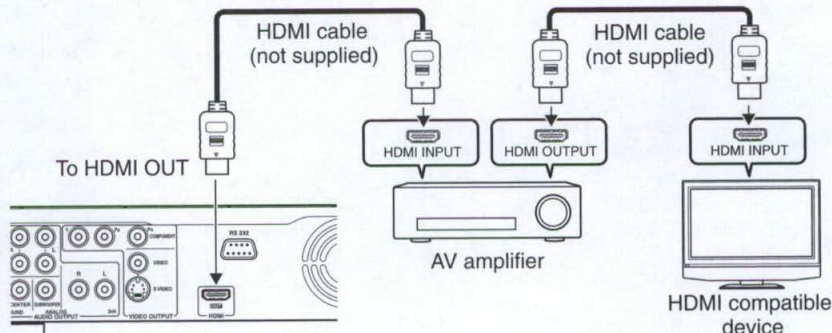

Caution

- When you are connecting (via the HDMI OUT jack) an AV decoder that does not have Dolby Digital or DTS decoding capability, be sure to set "Digital Out HDMI" (⇒ page 25) to "PCM" or "Downmixed PCM". Otherwise, high volume sound may damage your hearing as well as the speakers.

Note

- You may need to adjust the HDMI audio output to match the capabilities of your AV amplifier. In this case, set "Digital Out HDMI" (⇒ page 25) to "PCM".

Via digital audio output

You can listen to down-converted Dolby Digital Plus and Dolby TrueHD as well as Dolby Digital and DTS using a receiver with Dolby Digital and DTS decoding capabilities and an optical digital input.

This connection requires selection of "Digital Out SPDIF" (Step 16, ⇒ page 25).

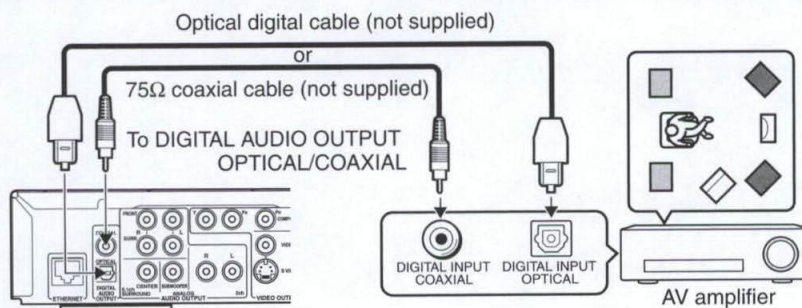

- * To use the digital output, use an optical /coaxial cable to connect either of these jacks to an audio input on a device capable of processing Dolby Digital, DTS bitstream, or PCM audio.

Preparation (Continued)

Via 5.1ch analog audio output

This connection requires selection of "Speaker Setting" (Step 16, ⇒ page 26).

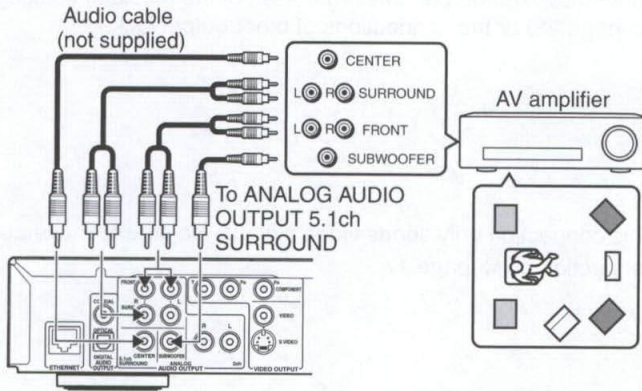

Via analog audio output

Sound is output only in 2ch format.

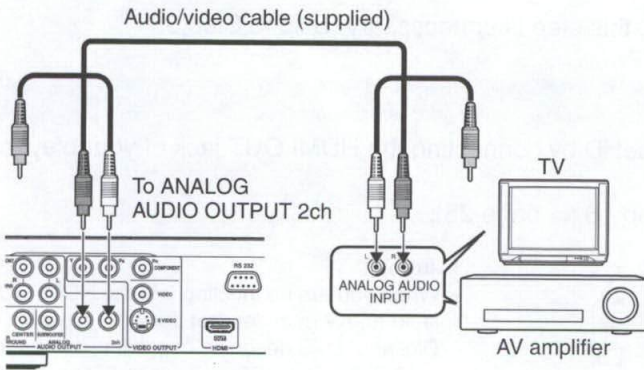

This connection only sends audio signals. Be sure to make video connection on ⇒ page 16.

Step 3: LAN connection

You may use the internet connection feature to update the player's firmware. See ⇒ page 41.

Some HD DVD discs may enable you to access special HD DVD sites, if you connect the player to the Internet via an always-on broadband connection. For example, if an HD DVD site includes content such as links to future movie trailers, you can watch the content on the player via the Internet. You do not need to connect to a PC to use this function.

Read the notes on ⇒ page 33 as well.

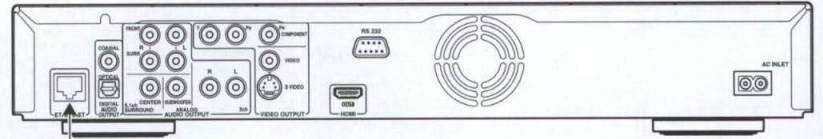

Connect either.

Use a commercially available straight LAN cable (Category 5/CAT5 or better with RJ45 connector).

Press down to remove

Lock portion

Plug

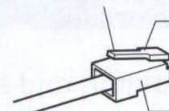

Caution

- When plugging or unplugging the LAN cable, hold the plug portion of the cable.
- When unplugging, do not pull on the LAN cable but unplug while pressing down on the lock.
- Do not connect a modular phone cable to the ETHERNET port.
- Since there are various connection configurations, please follow the specifications of your telecommunication carrier or internet service provider.

Note

- Depending on the internet service provider (ISP), the number of devices that can receive internet service may be limited by the applicable terms of service. For details, contact your ISP.

Preparation (Continued)

Step 4: Power connection

After completing all connections, connect the supplied power cord to the AC INLET socket and a wall outlet.

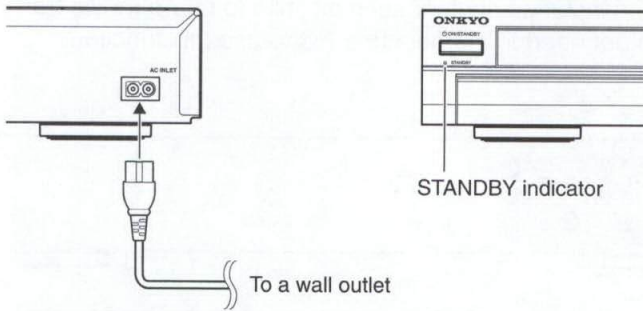

STANDBY indicator on the player illuminates in red.

Caution

- Do not power this player using any power cord other than the one supplied with this player.
- Do not use the supplied power cord with any device other than this player.

Step 5: Powering on

- 1 Turn on the TV or monitor, and select the input which the player is connected to.
- 2 Press ON/STANDBY.

ON/STANDBY button

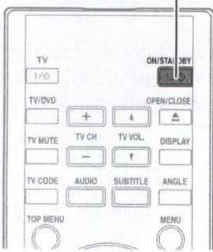

ON/STANDBY button

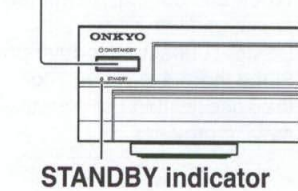

When the power turns on, STANDBY indicator on the front panel changes color from red (standby mode) to blue (operation).

Start up (and disc loading (⇒ page 29)) may take time.

When you power on this player for the first time, the setting menu will appear. Go to Step 6 to make the necessary setup.

- **To power off the player**
Press ON/STANDBY.

Step 6: Setting up the player

Make the settings which are necessary to operate the player.

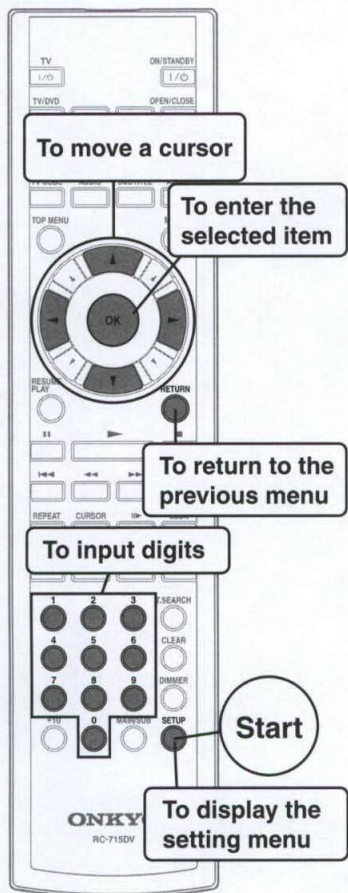

- 1 Make sure that the following menu is displayed.
(If not, press SETUP to display it.)

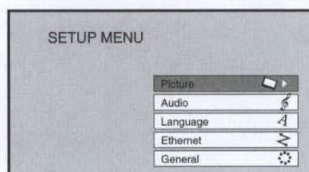

A: Language

- 2 Press ▲ / ▼ to select "Language", then press OK.

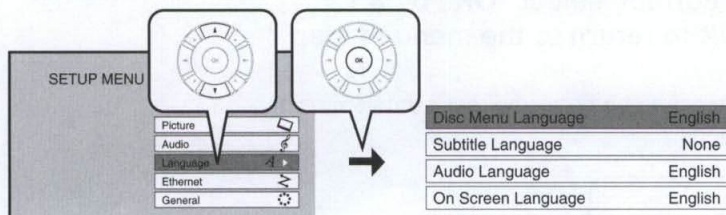

- 3 Press ▲ / ▼ to select "On Screen Language", then press OK.

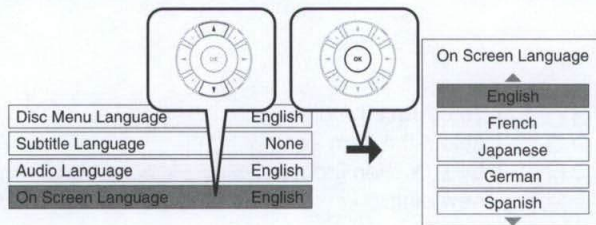

- 4 Press ▲ / ▼ to select the language you want use for on-screen displays, then press OK.
- 5 Press RETURN or ◀ to return to the menu of step 1.

Preparation (Continued)

B: Time

6 Press ▲ / ▼ to select “General”, then press OK.

10 Press RETURN or ◀ to return to the menu of step 1.

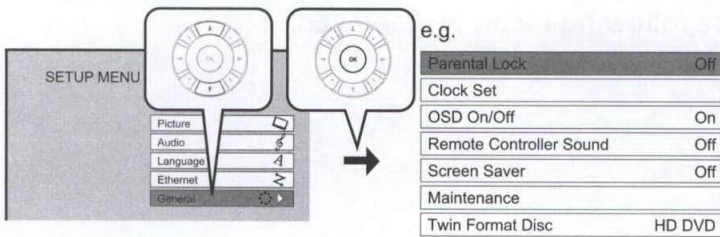

7 Press ▲ / ▼ to select “Clock Set”, then press OK.

8 Confirm the time is correct.

9 If the time is correct, select “OK” by ▲ / ▼, then press OK to return to the menu of step 6.

When the time needs to be corrected, set each item using the following buttons.

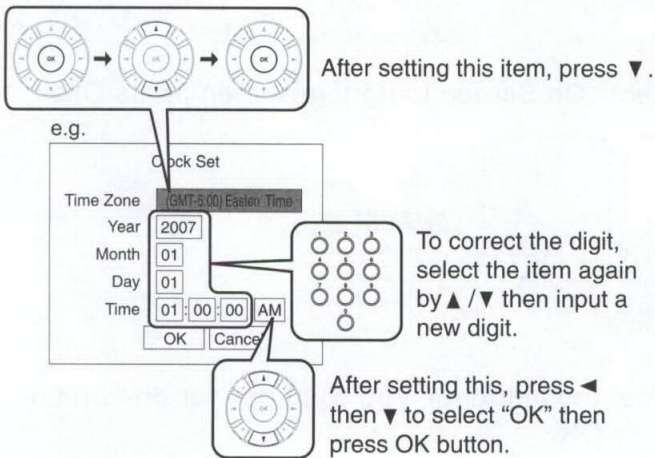

C: Resolution

11 Press ▲ / ▼ to select “Picture”, then press OK.

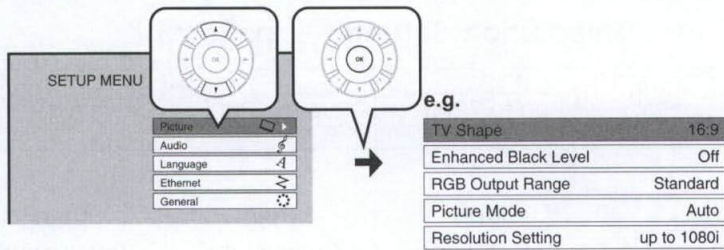

12 Press ▲ / ▼ to select “Resolution Setting”, then press OK.

13 Press ▲ / ▼ to select the resolution according to the performance of your TV as shown in the table below, then press OK.

TV input	“Resolution Setting”					
<p>HDMI input</p>	Select the resolution. e.g. <table border="1"> <tr><td>up to 480p</td></tr> <tr><td>up to 720p</td></tr> <tr><td>up to 1080i</td></tr> <tr><td>up to 1080p</td></tr> <tr><td>up to 1080p/24Hz</td></tr> </table>	up to 480p	up to 720p	up to 1080i	up to 1080p	up to 1080p/24Hz
up to 480p						
up to 720p						
up to 1080i						
up to 1080p						
up to 1080p/24Hz						
<p>Component video input</p>	Select the resolution (except “up to 1080p” and “up to 1080p/24Hz”) according to the performance of the connected TV. e.g. <table border="1"> <tr><td>up to 480p</td></tr> <tr><td>up to 720p</td></tr> <tr><td>up to 1080i</td></tr> <tr><td>up to 1080p</td></tr> <tr><td>up to 1080p/24Hz</td></tr> </table>	up to 480p	up to 720p	up to 1080i	up to 1080p	up to 1080p/24Hz
up to 480p						
up to 720p						
up to 1080i						
up to 1080p						
up to 1080p/24Hz						
<p>S-VIDEO or VIDEO (yellow) input</p>	“Resolution Setting” selection is not necessary.					

- You may find that setting the output resolution of the player to match as closely as possible the native resolution of your display provides the best picture performance (e.g., 720p for 720p and 1080p for 1080p).
- Refer to the table on the next page as well.

For best viewing of film movie material (24p output) **HD DVD** **DVD-Video**







Movies that are produced on film, as opposed to video, are traditionally captured at a frame rate of 24 frames per second. Your player can maintain the 24 frames per second frame rate of such movies, allowing you to enjoy them in their native form. To enable this feature, connect an HD display capable of accepting a 1080p/24Hz signal and select “up to 1080p/24Hz.”

Note

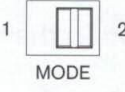
- Most film based HD DVDs display images at 24 frames per second and video based HD DVDs display images at 30 frames or 60 fields per second. Depending on the content, “up to 1080p/24Hz” may lower smoothness of playback and/or reduce vertical resolution. In the case of video based HD DVDs, we recommend that the output resolution setting is changed from “up to 1080p/24Hz”.

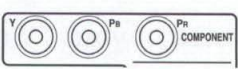
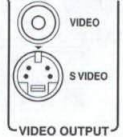
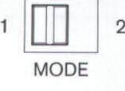
Preparation (Continued)

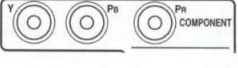
■ Settings and actual output resolution

MODE switch (⇨ page 15)	Output jacks on the player	“Resolution Setting” (⇨ page 23)			
		up to 480p (up to 480p/576p)	up to 720p	up to 1080i	up to 1080p (up to 1080p/24Hz)
 MODE	 HDMI	480p (480p/576p)	720p (maximum) ¹	1080i (maximum) ¹	1080p (maximum) ¹
	 Y Pb Pr COMPONENT	480p (480p/576p) ²	720p ²	1080i ²	No video output.
	 VIDEO S VIDEO VIDEO OUTPUT	No video output.			
 MODE	 HDMI	No video output.			
	 Y Pb Pr COMPONENT	480i (480i/576i)			
	 VIDEO S VIDEO VIDEO OUTPUT	480i (480i/576i)			

¹ Maximum of the player's actual resolution according to a connected HDMI TV. The order of precedence is 1080p>1080i>720p>480p (480p/576p).

² Fixed. However, when an HDMI TV is also connected to the player, the player will select resolution in the same manner as in HDMI connection, i.e., ¹.

14 Press RETURN or ◀ to return to the menu of step 1.

D: Audio output

15 Press ▲ / ▼ to select “Audio”, then press OK.

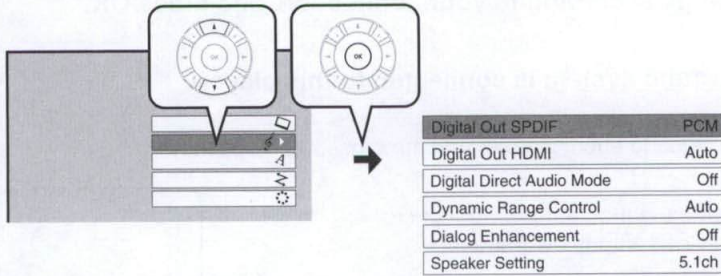

16 When you connected an audio system to the **DIGITAL AUDIO OUTPUT OPTICAL/COAXIAL** jack (⇒ page 17):

Press ▲ / ▼ to select “Digital Out SPDIF”, then press OK.

Select one of the followings according to your connection, and press OK.

Bitstream

When an AV receiver or processor equipped with built-in Dolby Digital, DTS or MPEG decoder is connected to this player.

When you play a disc recorded in Dolby Digital Plus or Dolby TrueHD format, Dolby Digital sound is output. When you play a disc recorded in DTS-HD format, the sound is converted to a DTS bitstream. If the AV receiver or processor does not support DTS, select “PCM”.

PCM

When a 2ch digital stereo amplifier is connected to this player.

When you play an HD DVD or DVD video disc recorded in Dolby Digital, Dolby Digital Plus, Dolby TrueHD, DTS or DTS-HD format, sound is converted into PCM (2ch) format.

When you connected an HDMI device to the **HDMI OUT** jack (⇒ page 16, 17):

Press ▲ / ▼ to select “Digital Out HDMI”, then press OK.

Select one of the followings according to your connection, and press OK.

Auto

When an HDMI device equipped with built-in Dolby Digital, DTS, MPEG or linear PCM decoder is connected to this player.

When you play a disc recorded in Dolby Digital Plus, Dolby TrueHD or DTS-HD, PCM is output (core only for DTS-HD).
When you play a disc recorded in Dolby Digital or DTS format, digital audio signal (bitstream audio) is output. If a connected HDMI device does not support Dolby Digital, DTS or MPEG, sound is converted into linear PCM to output.
To output high bitrate audio, select “Auto”, then make another setting. For details, see ⇒ page 34.

PCM

When an HDMI device which has multi channel input is connected to this player.

When you play an HD DVD or DVD video disc recorded in multi channel in Dolby Digital, Dolby Digital Plus, Dolby TrueHD, DTS or DTS-HD format, the sound is decoded and output in multi channel in linear PCM format.

Downmixed PCM

When a 2ch digital stereo AV receiver or processor is connected to this player.

When you play a DVD video disc recorded in Dolby Digital, DTS, MPEG1 or MPEG2 format, sound is converted into PCM (2ch) format to output.

Note

- Setting “Auto” or “PCM” will reduce output level of multi channel sound from the ANALOG AUDIO OUTPUT 2ch jacks and the DIGITAL AUDIO OUTPUT OPTICAL/COAXIAL jack if you:
 - view the playback picture on an HDMI TV connected to this player.
 - play an HD DVD video disc of a certain type, recorded in linear PCM format.
 In this case, the output level will be restored by setting to “Downmixed PCM”.

Preparation (Continued)

When you connected an audio system to the **ANALOG AUDIO OUTPUT** jacks (⇒ page 18):

Press ▲ / ▼ to select “Speaker Setting”, then press OK.

Select one of the followings according to your connection, and press OK.

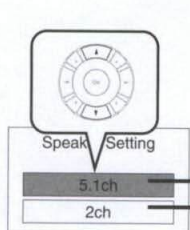

5.1ch

When a 5.1 channel surround system is connected to this player.

- 1 Set the speaker sizes, distance to each speaker and the crossover frequency.

Front Left / Front Right

Small: Select if the speaker cannot output low frequency.
Large: Select if the speaker can output low frequency.

Center / L Surround / R Surround

Small: Select if the speaker cannot output low frequency.
Large: Select if the speaker can output low frequency.
None: When the speaker is not connected.

Subwoofer

Use: When a subwoofer is connected.
Don't Use: When a subwoofer is not connected.

Crossover Setting

Low frequency under this frequency (80Hz / 100Hz / 120Hz) will be output to a connected subwoofer.

ft (m)

Select a distance to each speaker from the listening position.

- 2 Select “Next”, then press OK.
To cancel to return to the previous screen, select “Clear”, then press OK.
To save your selection and finish the setting, select “End”, then press OK.
- 3 Select “Automatic Test Tone”, then press OK.
A test signal is set to each speaker.
A loud test sound will be emitted. If you usually listen at a low volume, please take care.
- 4 Adjust each of the volumes by ▲ / ▼, selecting speakers by ◀ / ▶ so that each speaker can sound at the same volume.
For further adjustment, check the channel balance on the amplifier.
- 5 When complete, select “End”, then press OK.

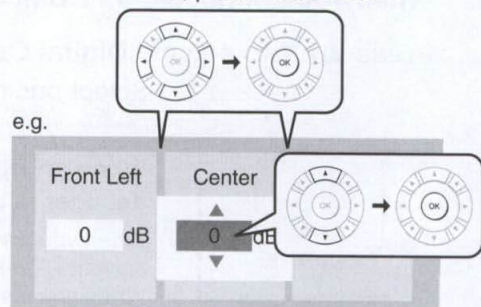
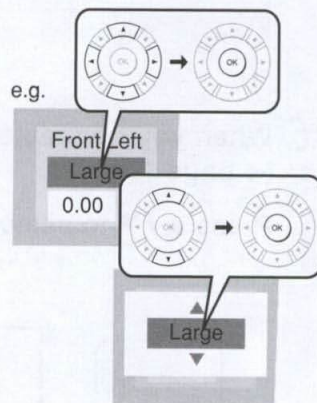

Note

- This setting is effective only when “Digital Out SPDIF” (⇒ page 25) is set to “PCM”.

2ch

When a 2ch stereo system is connected to this player.

17 Press RETURN or ◀ to return to the menu of step 1.

(Continued)

E: Ethernet

Perform this setting if you connect the player to your LAN (⇒ page 19).

After performing this setting, you need to turn off this player and turn it on again to activate this setting.

If you do not connect, skip to Step 20.

18 Press ▲ / ▼ to select “Ethernet”, then press OK.

19 Press ▲ / ▼ to select each of the followings, then press OK.

DHCP	Off	①	To set your network information.
Proxy Setting	Off	②	To input proxy server address (when your provider requires the setting).
MAC Address			
NTP Server	Off		To display the Mac address of the player. (Fixed. No need to set.)
Network Speed	56kbps Modem	③	To adjust the player’s clock via the network time protocol.
Cookie Setting	Accept	④	To select the speed according to the specification of your LAN.
		⑤	To select whether you access “Cookies” or not.

① DHCP

1 Set “DHCP” to “On” and press OK button.
The network information is automatically set.

2 Set “DNS” to “On” and press OK button.
The DNS server is obtained automatically from the DHCP server.

3 Select “Confirm”, then press OK button.
Confirming starts.
If the setup is successful, an IP address appears. Press OK button.

Skipped when “DHCP” is set to “On”.

Skipped when “DNS” is set to “On”.

If the setup is not successful:

a) Set “DHCP” to “Off” and press OK button.

b) Input the addresses using the number buttons.

“IP Address”	This sets a different address within the same subnet of the PC on your network. e.g. if the IP address of the PC is 192.168.1.10, set 192.168.1.15 (or some other unused address.)
“Subnet Mask”	This sets the subnet mask of the network environment that will be connected. e.g.: 255.255.255.0
“Gateway”	This sets the gateway used by the player (e.g.: 192.168.1.1).
“DNS Server”	This sets the DNS server to be used by the player (e.g.: 192.168.1.1).

c) Select “OK” and press OK button.

② Proxy Setting

Enter the proxy server address when your provider requires proxy setting.

1 Set “Proxy” to “On” and press OK button.

2 Enter the specified data from the provider.
Refer to the instructions below for inputting characters. (Server, Port)

3 Select “OK” and press OK button.

How to input characters	
OK button	To begin or finish input.
▲ / ▼ buttons	To select a character.
◀ / ▶ buttons	To move to the next character.
CLEAR button	To erase to correct.
Number buttons	To input a number.

③ NTP Server

Select “On” or “Off” and press OK button.

“On”	The player automatically accesses an internet server to adjust time protocol.
“Off”	The player does not access an internet server to adjust its clock.

Preparation (Continued)

④ Network Speed

Select the speed and press OK button.

For other speeds:
1 Select "Other" and press OK button.

Network Speed (Other)

1 kbps

OK Cancel

2 Specify the speed by number buttons.
3 Select "OK" and press OK button.

Network Speed

28.8kbps Modem	33.6kbps Modem
56kbps Modem	64kbps ISDN
128kbps ISDN	256kbps DSL/Cable
384kbps DSL/Cable	512kbps DSL/Cable
768kbps DSL/Cable	1Mbps Cable
1.5Mbps T1	Over 10Mbps
Other	

⑤ Cookie Setting

Select "Accept" or "Not Accept" and press OK button.

"Accept" Cookies are accepted.

"Not Accept" Cookies are rejected.
This may disable some services on web pages.

Cookie Setting

Accept

Not Accept

20 Press RETURN or ◀ to return to the menu of step 1.

21 Press SETUP to close the menu.

22 If you made the LAN setting ("E: Ethernet", ⇒ page 27), press ON/STANDBY to turn the player off, then press the button again to turn it on.

Your player is ready.

Playing

Preparation

- Turn on the TV or audio system and select the corresponding input source that the player is connected to.
- Turn the power on. (⇒ page 20)

Playing a disc

HD DVD DVD-Video DVD-RW DVD-R CD

1 Press **▲** (OPEN/CLOSE) to open the disc tray.

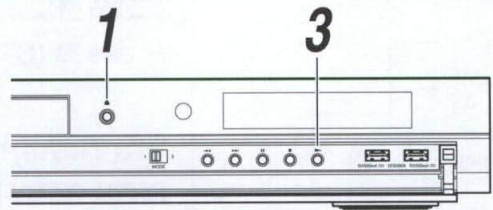

2 Place a disc in the hollow of the disc tray with the playback side down.

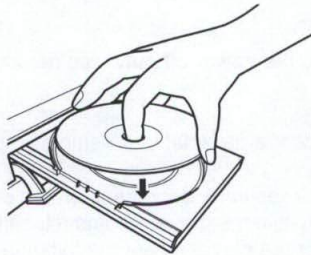

When using a double-sided disc, turn the label of the playing side up.

3 After placing a disc, press **▲** (OPEN/CLOSE).

Playback starts.

If playback does not start, press **▶** (PLAY).

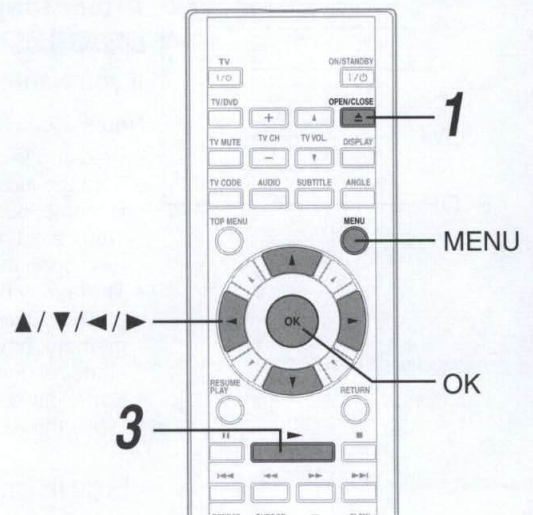

HD DVD DVD-Video

If a loaded disc contains a top menu, a top menu appears when you start playback.

Select a title by **▲ / ▼ / ◀ / ▶** (or **number buttons**), then press **OK**.

Playback starts from chapter 1 of the selected title.

- Depending on the disc, you may need to press TOP MENU or MENU to display a top menu.

DVD-RW DVD-R

Discs recorded on personal devices such as DVD recorders may contain menus, on which items can be easily selected.

Press **MENU**, and select a title by **▲ / ▼ / ◀ / ▶**, then press **OK**.

Playback starts from the selected item.

- Discs recorded in DVD VR mode display the recorded contents not in thumbnails but in a list. Select an item on the list and press OK button.

Notes

- Use the button on the front panel or the remote control to open and close the disc tray. Do not push or hold the disc tray while it is moving. Doing so may cause the player to malfunction.
- Do not load a disc which is unplayable, or any object other than a playable disc.
- Do not apply downforce to the disc tray. Doing so may cause the player to malfunction.
- If the disc tray stops while closing, the mechanical protection system of this player will open it. Do not force it to close. Doing so may damage the disc tray.
- If the disc tray will not open, turn the player off, and press **▲** (OPEN/CLOSE) on the front panel. This may turn the player on and open the disc tray. If it still won't open, contact your Onkyo dealer.

Playing (Continued)

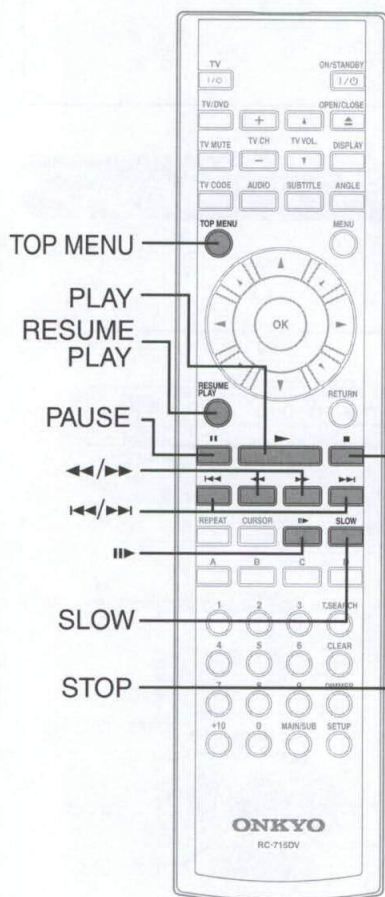

To pause playback

HD DVD DVD-Video DVD-RW DVD-R CD

Press **||** (PAUSE).

To resume press **▶** (PLAY).

To stop playback

HD DVD DVD-Video DVD-RW DVD-R CD

Press **■** (STOP).

To resume playback from the location last stopped

HD DVD DVD-Video DVD-RW DVD-R

After stopping playback, press **RESUME PLAY** (HD DVD) or **▶** (PLAY) (DVD-Video DVD-RW DVD-R CD).

If you want to return to the beginning, press **■** (STOP), then press **▶** (PLAY).

Notes

- Pressing **▶** (PLAY) after stopping playback then turning the power off may also resume playback from the location last stopped.
- Resume feature cannot function when:
 - you select a disc menu language (⇒ page 38) or change the parental lock setting (⇒ page 40).
 - you open the disc tray.
- There may be a difference in the location where playback resumes depending on the disc.
- It is possible to change the setting from the setup menu while the player retains a location in memory, however, the new setting can be valid only after the player clears the location memory, i.e., starts resume playback.
- Some discs or scenes may not permit this operation.
- While the ADV indicator on the front panel illuminates, this feature is not available.

Basic operations table

HD DVD DVD-Video DVD-RW DVD-R CD

Button	Function	Operation	To cancel
◀◀	Fast reverse playback	Pressing this button repeatedly changes the playback speed.	▶ (PLAY)
▶▶	Fast forward playback	Pressing this button repeatedly changes the playback speed.	▶ (PLAY)
SLOW*1	Playing in slow-motion	Pressing this button repeatedly changes the playback speed.	▶ (PLAY)
▶*1*2	Playing frame by frame	1 Press (PAUSE) to pause playback. 2 Press this button repeatedly.	▶ (PLAY)
▶▶	To skip to the next chapter/track	Press this button once.	-
◀◀	To return to the previous chapter/track	Pressing this button once locates the beginning of the current chapter or track. Pressing this button twice locates the beginning of the previous chapter or track.	-
TOP MENU*1	To display a top menu	1 Press this button. 2 Press ▲/▼/◀/▶ to select a title. 3 Press OK.	TOP MENU

*1 Not available in CD playback.

*2 Some discs may not permit this operation.

Note

- If the player freezes for about 15 minutes or more and will not respond to any buttons, holding down ON/STANDBY button on the front panel for about 10 seconds can force the player to turn off. However, this is an emergency measure, which may cause damage to the player. Avoid casual use of this measure.

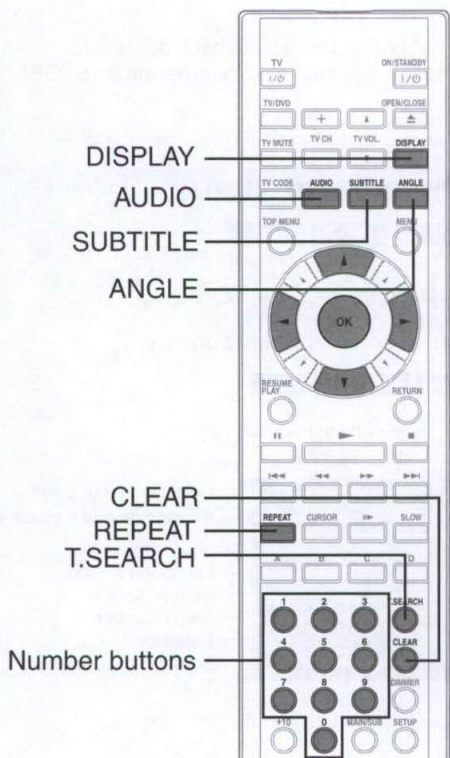

To select subtitles

HD DVD DVD-Video

You can display subtitles on the TV and select a subtitle language from those included on the disc.

1 During playback, press SUBTITLE.

The current subtitle setting appears. (except for some HD DVD discs)

e.g.

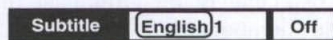

A language code (⇒ page 39) may appear.

Each time you press ◀/▶, "On" and "Off" alternates. Select "On" to view subtitles.

2 Press SUBTITLE while the subtitle setting is displayed on the TV screen.

Subtitle languages which do not appear in the setting are not included in the disc.

Notes

- Some discs are set to display subtitles automatically.
- Depending on the scene, subtitles may not appear immediately after you set the subtitle function to on.
- Some discs will allow you to change subtitle languages and turn subtitles on or off only via the disc menu.
- When you turn on the player or replace a disc, the player returns to the initial default setting (⇒ page 38). Depending on a disc, a specific type of subtitles the disc has is output.
- Depending on the scene, the subtitle language may not change immediately after selected.

To select the sound

HD DVD DVD-Video DVD-RW DVD-R

If a disc contains several languages, you can select a preferred language from them to hear.

1 During playback, press AUDIO.

The current audio setting appears. (except for some HD DVD discs)

e.g.

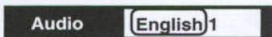

A language code (⇒ page 39) may appear.

2 Press AUDIO while the audio setting is displayed on the TV screen.

Notes

- Some discs allow you to change audio selections only via the disc menu. If this is the case, press MENU button and choose the appropriate language from the selections on the disc menu.
- When you turn on the player or replace a disc, the player returns to the initial default setting (⇒ page 38). Depending on a disc, a specific type of audio the disc has is output.
- Immediately after you have switched audio output modes, there may be a temporary discrepancy between the display and actual sound.

To select the camera angle

HD DVD DVD-Video

If the scene was recorded with multiple angles, you can easily change the camera angle of the scene you are watching.

1 While playing a scene recorded with multiple angles (angle icon () displayed on the TV and the front panel), press ANGLE.

The current angle setting appears. (except for some HD DVD discs)

e.g.

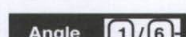

Number of angles in the current title

Angle number

2 While the angle number is displayed, press ANGLE repeatedly to select the angle number.

Notes

- You can also change the camera angle during still playback. The camera angle changes to the new setting when you resume normal playback.
- If you pause a picture immediately after changing a camera angle, the resumed playback picture may not display the new camera angle.

Playing (Continued)

To locate a position

HD DVD DVD-Video DVD-RW DVD-R CD

- 1 Press T.SEARCH repeatedly to select the category.

Category	To search by specifying:
Title	Title number
Chapter	Chapter number
Time	Elapsed time of the current title (track)
Track	Track number

- 2 Press the number buttons to enter a number.

e.g. To enter 25:

"2" → "5"

e.g. To enter 1 hour, 25 minutes, and 30 seconds:

"1" → "2" → "5" → "3" → "0"

Pressing CLEAR resets the numbers.

- 3 Press OK.

Playback starts from the specified location.

Notes

- Some discs may not permit these operations.
- While the ADV indicator on the front panel illuminates, these features are not available.

- 3 Press OK.

Repeat playback starts.

Notes

- Some discs may not permit repeat playback operation.
- You can cancel repeat playback also by pressing ■ (STOP).

To check the current status

HD DVD DVD-Video DVD-RW DVD-R CD

- 1 Press DISPLAY.

The following on-screen display appears.

HD DVD DVD-Video DVD-RW DVD-R

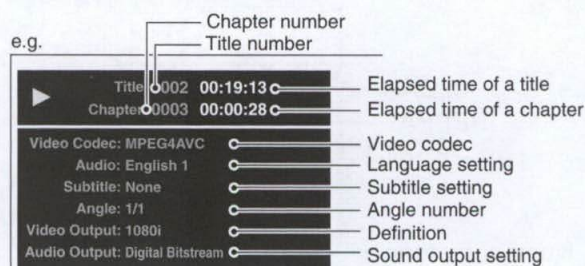

CD

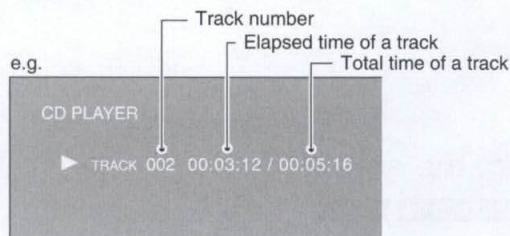

- 2 After confirming, press DISPLAY to turn off the display.

To play repeatedly

DVD-Video DVD-RW DVD-R CD

- 1 During playback, press REPEAT.

The repeat modes are listed.

- 2 Press ▲ / ▼ to select the repeat mode.

(The selections on the list vary depending on category or status of a disc.)

Mode	To repeat:
All Repeat	Entire disc
Title Repeat	Current title
Chapter Repeat	Current chapter
Track Repeat	Current track
Disc Repeat	Entire disc
A-B Repeat	<p>You can specify a segment to repeat. Select this and press OK.</p> <p>"A B Repeat A Point" appears.</p> <p>Perform steps 1) and 2) below, and skip step 3.</p> <p>1) While the above display appears, press OK at a start point of a segment where you want to repeat. The display changes to "A B Repeat B Point".</p> <ul style="list-style-type: none"> • To cancel the setting, press REPEAT. <p>2) Press OK at an end point of a segment where you want to repeat. Playback returns to the point A and repeats between A and B.</p>
Cancel	Repeat playback is canceled.

HD DVD playing options in the future

A/B/C/D buttons

HD DVD

Use these buttons as indicated by the video display during HD DVD disc playback. Depending on the disc contents, the functions of each button may differ.

Cursor controls

HD DVD

Future HD DVD discs may include game software and drawing software. If they do you can use the cursor function for some software.

- 1 Press CURSOR while a disc with support for cursor use is playing.**
- 2 Use the eight direction buttons to move the cursor.**

Move the cursor to select the game target or selection item. For details on actual operations, also refer to the operations guide for the disc.

Controller port

HD DVD

The extension port may be used in the future for additional control options.

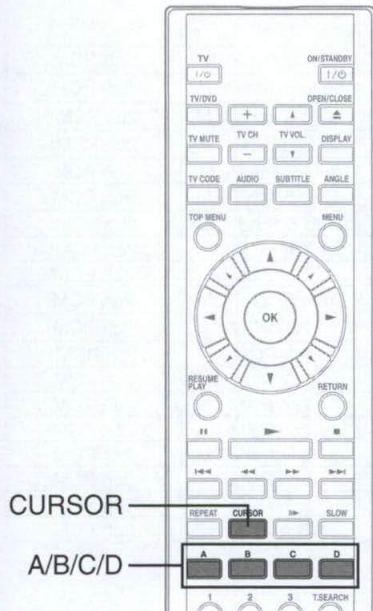

EXTENSION port

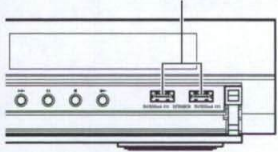

Requirements for HD DVD discs/Web-enabled network content

- An always-on broadband internet connection
- An HD DVD disc containing or having the capability of downloading studio-provided, web-enabled network content.

Notes

- To minimize any potential compatibility and/or connectivity issues, before attempting to view any studio-provided web-enabled, network content, it is recommended that you perform the firmware update process to ensure that your HD DVD player is using the latest firmware version.
- Onkyo is not responsible for any malfunction of the player and/or the internet connection feature due to communication errors/malfunctions associated with your broadband internet connection, or other connected equipment.
- Onkyo is not responsible for any trouble in your internet connection.
- If you wish to use a wireless network to connect the player, you will need to use a wireless LAN ethernet adapter to connect the player to the network.
- The features of HD DVD discs made available through the Internet Connection feature are not created or provided by Onkyo, and Onkyo is not responsible for their functionality or continued availability. Some disc related material available by the Internet Connection may not be compatible with this player. If you have questions about such content, please contact the producer of the disc.
- Some internet contents may require a higher bandwidth connection.
- Even if the player is properly connected and configured, some internet contents may not operate properly because of internet congestion, the quality or bandwidth of your internet service, problems at the provider of the content or compatibility issues.
- Some internet connection operations may not be possible due to certain restrictions set by the Internet service provider (ISP) supplying your broadband Internet connection.
- Any fees charged by an ISP including, without limitation, connection charges are your responsibility.
- A 10 Base-T or 100 Base-TX LAN port is required for connection to this player. If your internet service does not allow for such a connection, you will not be able to connect the player.
- A DSL modem is required to use DSL service and a cable modem is required to use cable modem service. Depending on the access method of and subscriber agreement with your ISP, you may not be able to use the internet connection feature contained in this player or you may be limited to the number of devices you can connect at the same time. (If your ISP limits subscription to one device, this player may not be allowed to connect when a PC is already connected.)
- The use of a "Router" may not be allowed or its usage may be limited depending on the policies and restrictions of your ISP. For details, contact your ISP directly.

Output sound conversion table

Disc	ADV indicator	Audio format	"Digital Out SPDIF"		"Digital Out HDMI"		
			Bitstream	PCM	Auto	PCM ²	Downmixed PCM
HD DVD Video Advanced content	ADV	DD Plus/Dolby TrueHD	Dolby Bitstream	2ch PCM	Depend on HDMI receiver	up to 5.1ch PCM ³	2ch PCM ¹
		dts-HD/L-PCM	DTS Bitstream	2ch PCM			
HD DVD Video Standard content	(off)	DD plus	Bitstream	2ch PCM	Depend on HDMI receiver	up to 5.1ch PCM ²	2ch PCM
		True HD 48kHz	Dolby Bitstream	2ch PCM	Depend on HDMI receiver	up to 5.1ch PCM	2ch PCM
		96kHz	Dolby Bitstream	2ch PCM ¹	Depend on HDMI receiver	up to 5.1ch PCM	2ch PCM ¹
		192kHz	Dolby Bitstream	2ch PCM ¹	Depend on HDMI receiver	2ch PCM ¹	2ch PCM ¹
		dts-HD	Bitstream	2ch PCM	Depend on HDMI receiver	up to 5.1ch PCM ²	2ch PCM
		L-PCM 48kHz	DTS Bitstream	2ch PCM	Depend on HDMI receiver	up to 5.1ch PCM	2ch PCM
		96kHz	DTS Bitstream	2ch PCM ¹	Depend on HDMI receiver	up to 5.1ch PCM ³	2ch PCM ¹
		192kHz	DTS Bitstream	2ch PCM ¹	Depend on HDMI receiver	2ch PCM ³	2ch PCM ¹
DVD-Video	(off)	MPEG	Bitstream	2ch PCM	Depend on HDMI receiver	2ch PCM	2ch PCM
		DD	Bitstream	2ch PCM	Depend on HDMI receiver	up to 5.1ch PCM	2ch PCM
		L-PCM 48kHz	2ch PCM	2ch PCM	2ch PCM	2ch PCM	2ch PCM
		96kHz	2ch PCM ¹	2ch PCM ¹	2ch PCM	2ch PCM ³	2ch PCM ¹
		dts	Bitstream	2ch PCM	Depend on HDMI receiver	up to 5.1ch PCM	2ch PCM
CD	(off)	L-PCM 44.1kHz	2ch PCM	2ch PCM	2ch PCM	2ch PCM	2ch PCM
		dts 44.1kHz	Bitstream	2ch PCM	Depend on HDMI receiver	up to 5.1ch PCM	2ch PCM
DVD-VR	(off)	DD	Bitstream	2ch PCM	Depend on HDMI receiver	2ch PCM	2ch PCM
		L-PCM	2ch PCM	2ch PCM	2ch PCM	2ch PCM	2ch PCM
		MPEG	Bitstream	2ch PCM	Depend on HDMI receiver	2ch PCM	2ch PCM

Disc	ADV indicator	Audio format	ANALOG AUDIO OUTPUT 5.1ch SURROUND
HD DVD Video Advanced content	ADV	DD Plus/Dolby TrueHD	up to 5.1ch PCM
		dts-HD/L-PCM	up to 5.1ch PCM
HD DVD Video Standard content	(off)	DD plus	up to 5.1ch PCM
		True HD 48kHz	up to 5.1ch PCM
		96kHz	up to 5.1ch PCM
		192kHz	2ch PCM
		dts-HD	up to 5.1ch PCM
		L-PCM 48kHz	up to 5.1ch PCM
		96kHz	up to 5.1ch PCM
		192kHz	2ch PCM
DVD-Video	(off)	MPEG	2ch PCM
		DD	up to 5.1ch PCM
		L-PCM 48kHz	2ch PCM
		96kHz	2ch PCM
		dts	up to 5.1ch PCM
CD	(off)	MPEG	2ch PCM
		L-PCM 44.1kHz	2ch PCM
DVD-VR	(off)	dts 44.1kHz	up to 5.1ch PCM
		DD	2ch PCM
		L-PCM	2ch PCM
		MPEG	2ch PCM

1: Downsamped PCM.

2: Up to 5.1 channel PCM audio output is possible only when the connected device supports multi channel output.

3: This output format is possible when the resolution setting is "720p", "1080i" or "1080p". When the resolution setting is set to "480p (480p/576p)", this output format depends on HDMI receiver.

Notes

- The main title content of most movie HD DVD discs is "advanced content". The player turns on the ADV indicator when an HD DVD disc which includes such content is loaded.
- The DIGITAL AUDIO OUTPUT OPTICAL/COAXIAL jack may not output sound you select. In this instance, set "Digital Out SPDIF" to "PCM".
- The ANALOG AUDIO OUTPUT 2ch jacks always output 2ch sound only.

Customizing the function settings

You can change the default settings to customize performance to your preference.

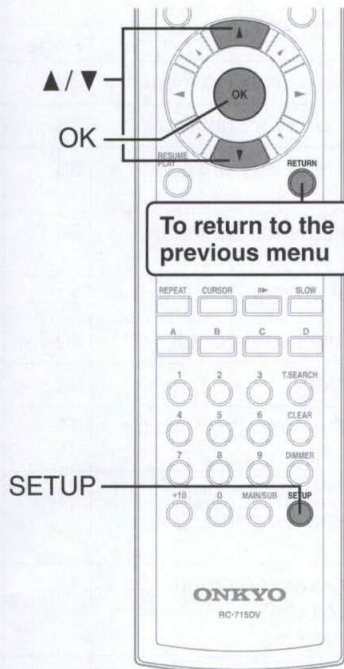

1 During stop, press **SETUP**.

“SETUP MENU” appears.

2 Press **▲ / ▼** to select the group that contains a desired item, then press **OK**.

3 Press **▲ / ▼** to select the setting item, then press **OK**.

4 Refer to the explanations on pages beginning from 33, to change the selection by **▲ / ▼** or other buttons, then press **OK**.

5 Repeat step 3 and 4 to set other items if necessary.

6 Press **SETUP**.

“SETUP MENU” disappears and the setting is completed.

Group	Setting	Disc	Details	Page
Picture	TV Shape	HD DVD DVD-Video DVD-RW DVD-R CD	To select a picture size according to the aspect ratio of your TV.	36
	Enhanced Black Level (North American models only)	HD DVD DVD-Video DVD-RW DVD-R	To select the black level (0 IRE or 7.5 IRE).	36
	RGB Output Range	HD DVD DVD-Video DVD-RW DVD-R	To select the RGB range according to the capacity of the connected DVI monitor.	37
	Picture Mode	HD DVD DVD-Video DVD-RW DVD-R	To select the system of output signal corresponding to playback source. (Only when connected to a PROGRESSIVE TV.)	37
	Resolution Setting	HD DVD DVD-Video DVD-RW DVD-R	To select the resolution of the player's output, according to the connected TV.	23
Audio	Digital Out SPDIF	HD DVD DVD-Video DVD-RW DVD-R CD	To select the output sound format when connecting the DIGITAL AUDIO OUTPUT jack.	25
	Digital Out HDMI	HD DVD DVD-Video DVD-RW DVD-R CD	To select the output sound format when connecting the HDMI OUT jack.	25
	Digital Direct Audio Mode	HD DVD	To output high bitrate audio to a connected amplifier equipped with Dolby Digital Plus, Dolby TrueHD or DTS-HD decoder.	37
	Dynamic Range Control	HD DVD DVD-Video DVD-RW DVD-R	To turn on or off a function that makes faint sounds easier to hear even if you lower the volume during late-hour playback.	37
	Dialog Enhancement	HD DVD DVD-Video DVD-RW DVD-R	To turn on or off a function that increases dialog volume of a disc playback.	38
	Speaker Setting	HD DVD DVD-Video DVD-RW DVD-R CD	To select various parameters for the analog 5.1ch output.	26

Customizing the function settings (Continued)

Group	Setting	Disc	Details	Page
Language	Disc Menu Language	HD DVD DVD-Video	To select a preferred language for disc menus.	38
	Subtitle Language	HD DVD DVD-Video	To select a preferred language for subtitles.	38
	Audio Language	HD DVD DVD-Video	To select a preferred language for the sound track.	38
	On Screen Language	HD DVD DVD-Video DVD-RW DVD-R CD	To select a preferred language for on-screen displays.	38
Ethernet		HD DVD	To set up internet connection feature.	27
General	Parental Lock	HD DVD DVD-Video	To turn the parental lock function on or off.	40
	Clock Set	HD DVD DVD-Video DVD-RW DVD-R CD	To set the clock of the player.	22
	OSD On/Off	HD DVD DVD-Video DVD-RW DVD-R CD	To activate or deactivate the operational status display on the TV screen.	41
	Remote Controller Sound	HD DVD DVD-Video DVD-RW DVD-R CD	To turn on or off the confirmation beeper announcing when each remote command is received.	41
	Screen Saver (North American models only)	HD DVD DVD-Video DVD-RW DVD-R CD	To turn on or off the screen saver (screen protection to prevent image burn).	41
	Maintenance	HD DVD DVD-Video DVD-RW DVD-R CD	To reset player options to factory defaults or check for firmware updates.	41
	Twin Format Disc	HD DVD	To select the layer to play of an HD DVD Twin Format Disc. (Not available while a disc is loaded.)	41

Settings

Picture

Note

- Actual effects of these settings may vary depending on performance of connected device.

TV Shape

16:9	Select when a 16:9 wide TV is connected.
4:3	Select when a standard 4:3 TV is connected. Displays pictures cropped to fill your TV screen. Both of the picture's sides are cut off.
4:3 Letter Box	Select when a standard 4:3 TV is connected. Displays theatrical images with masking bars above and below the picture.

Notes

- When an HD DVD disc or a DVD video disc has a particular available picture shape, the contents may not be compatible with other picture shapes.
- DVD video discs containing 4:3 picture only always display 4:3 pictures regardless of this setting.
- If "16:9" is selected while connecting a 4:3 TV, playback pictures may be distorted horizontally or shrink vertically. Make this setting according to your TV shape.
- Actual picture shape may depend on signal types of broadcasts or input sources, or settings on the connected TV. Refer to the owner's manual of your TV.

Enhanced Black Level (North American models only)

On	To display deeper, richer black than in "Off" setting. (0 IRE)
Off	Normal black level. (7.5 IRE)

Note

- Effective only in 480i output from the COMPONENT VIDEO OUTPUT jacks or the VIDEO OUTPUT jack.

(Continued)

RGB Output Range

Standard	For a monitor of RGB range 16-235.
Enhanced	For a monitor of RGB range 0-255.

Note

- If "Standard" pales black of "Enhanced" blackens too much, change the setting.

Picture Mode

There are two types of source content in pictures recorded in DVD video discs: film content (pictures recorded from films at 24 frames per second) and video content (video signals recorded at 30 frames in NTSC (25 frames in PAL) per second). Make this selection according to the type of content being viewed.

Film	The player converts film content pictures in the progressive output format appropriately. Suitable for playback of film content pictures.
Video	The player filters video signal, and converts it in the progressive output format appropriately. Suitable for playback of video content pictures.
Auto	Select this position normally. The player automatically detects source content, film or video, of playback source, and converts that signal in the progressive output format in an appropriate method.

Note

- The player may not be able to detect the source (film or video) of some material. If you notice undesirable picture performance, try selecting "Film" or "Video".

Resolution Setting

See ⇒ page 23.

Audio

Digital Out SPDIF

See ⇒ page 25.

Digital Out HDMI

See ⇒ page 25.

Digital Direct Audio Mode

To output high bitrate audio to a connected amplifier equipped with Dolby Digital Plus, Dolby TrueHD or DTS-HD decoder.

On	High bitrate audio output is enabled. (Sub audio and effect audio are disabled.)
Off	High bitrate audio output is disabled.

Notes

- This selection is available only when the player is connected to an amplifier equipped with Dolby Digital Plus, Dolby TrueHD or DTS HD decoder.
- To obtain high bitrate audio output, "Digital Out HDMI" (⇒ page 25) needs to be set to "Auto".
- While playing high bitrate audio, sound outputs from the ANALOG AUDIO OUTPUT and the DIGITAL AUDIO OUTPUT OPTICAL/ COAXIAL jack are disabled.
- To play high bitrate audio, be sure to select input from the player on the connected amplifier beforehand. If you select it after playback starts, high bitrate audio may not be heard. In this case, you may obtain full output if you stop the player then restart the playback.

Dynamic Range Control

To turn on or off a function that makes faint sounds easier to hear even if you lower the volume during late-hour playback.

Auto	While playing an HD DVD video disc recorded in Dolby TrueHD format, this function will be automatically activated or disabled according to certain command included in the content. For other discs, this function is activated.
On	This function is activated.
Off	This function is disabled.

Notes

- This function is effective only in playback of HD DVD or DVD video discs recorded in Dolby Digital, Dolby Digital Plus or Dolby TrueHD format.
- The effect level of this function vary depending on the disc.
- Not effective in Dolby TrueHD 96 kHz 5.1 channel sound.

Customizing the function settings (Continued)

Dialog Enhancement

To turn on or off a function that increases dialog volume of a disc playback.

On	This function is activated.
Off	This function is disabled.

Notes

- This function is effective only in playback of Dolby Digital recorded HD DVD or DVD video discs.
- The effect level of this function vary depending on the disc.

Speaker Setting

See ⇒ page 26.

Language

Disc Menu Language

To select a preferred language for disc menus.

English / French / Japanese / German / Spanish / Italian / Dutch / Russian / Swedish / Finnish / Greek / Turkish

Other	To make a further language choice. Refer to "How to select a language" (⇒ page 39).
--------------	--

Note

- Some discs may be played in a different language from that you selected, as the disc may contain alternate language.

Subtitle Language

To select a preferred language for subtitles.

English / French / Japanese / German / Spanish / Italian / Dutch / Russian / Swedish / Finnish / Greek / Turkish

None	To disable subtitles.
Other	To make a further language choice. Refer to "How to select a language" (⇒ page 39).

Notes

- Some discs may be set to display subtitles in a different language from that you selected, as the disc may contain alternate language.
- Some discs allow you to change subtitle selections only via the disc menu. In this case, press MENU button and choose the appropriate subtitle language from the selection on the disc menu.

Audio Language

To select a preferred language for the sound track.

English / French / Japanese / German / Spanish / Italian / Dutch / Russian / Swedish / Finnish / Greek / Turkish

Other	To make a further language choice. Refer to "How to select a language" (⇒ page 39).
--------------	--

Note

- Some discs may be played in a different language from that you selected, as the disc may contain alternate language.

On Screen Language

To select a preferred language for on-screen displays.

English / French / Japanese / German / Spanish / Italian / Dutch / Russian / Swedish / Finnish / Greek / Turkish

How to select a language:

- 1) Obtain the code from the list below.
- 2) Enter the code as below.
- 3) Select "OK" and press OK button.

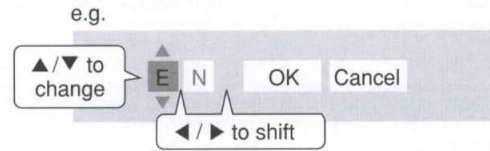

Language code list

Code	Language	Code	Language	Code	Language	Code	Language	Code	Language
---	No alternate language	DZ	Bhutani	KS	Kashmiri	SA	Sanskrit	VI	Vietnamese
		EL	Greek	KU	Kurdish	SD	Sindhi	VO	Volapük
CHI (ZH)	Chinese	EO	Esperanto	KY	Kirghiz	SG	Sango	WO	Wolof
DUT (NL)	Dutch	ET	Estonian	LA	Latin	SH	Serbo-Croatian	XH	Xhosa
ENG (EN)	English	EU	Basque	LN	Lingala	SI	Singhalese	YO	Yoruba
FRE (FR)	French	FA	Persian	LO	Laotian	SK	Slovak	ZU	Zulu
GER (DE)	German	FI	Finnish	LT	Lithuanian	SL	Slovenian		
ITA (IT)	Italian	FJ	Fiji	LV	Latvian, Lettish	SM	Samoan		
JPN (JA)	Japanese	FO	Faroese	MG	Malagasy	SN	Shona		
KOR (KO)	Korean	FY	Frisian	MI	Maori	SO	Somali		
MAY (MS)	Malay	GA	Irish	MK	Macedonian	SQ	Albanian		
SPA (ES)	Spanish	GD	Scottish Gaelic	ML	Malayalam	SR	Serbian		
AA	Afar	GL	Galician	MN	Mongolian	SS	Siswati		
AB	Abkhazian	GN	Guarani	MO	Moldavian	ST	Sesotho		
AF	Afrikaans	GU	Gujarati	MR	Marathi	SU	Sundanese		
AM	Amharic	HA	Hausa	MT	Maltese	SV	Swedish		
AR	Arabic	HI	Hindi	MY	Burmese	SW	Swahili		
AS	Assamese	HR	Croatian	NA	Nauru	TA	Tamil		
AY	Aymara	HU	Hungarian	NE	Nepali	TE	Telugu		
AZ	Azerbaijani	HY	Armenian	NO	Norwegian	TG	Tajik		
BA	Bashkir	IA	Interlingua	OC	Occitan	TH	Thai		
BE	Belorussian	IE	Interlingue	OM	(Afan) Oromo	TI	Tigrinya		
BG	Bulgarian	IK	Inupiak	OR	Oriya	TK	Turkmen		
BH	Bihari	IN	Indonesian	PA	Panjabi	TL	Tagalog		
BI	Bislama	IS	Icelandic	PL	Polish	TN	Setswana		
BN	Bengali, Bangla	IW	Hebrew	PS	Pashto, Pushto	TO	Tongan		
BO	Tibetan	JI	Yiddish	PT	Portuguese	TR	Turkish		
BR	Breton	JW	Javanese	QU	Quechua	TS	Tsonga		
CA	Catalan	KA	Georgian	RM	Rhaeto-Romance	TT	Tatar		
CO	Corsican	KK	Kazakh	RN	Kirundi	TW	Twi		
CS	Czech	KL	Greenlandic	RO	Rumanian	UK	Ukrainian		
CY	Welsh	KM	Cambodian	RU	Russian	UR	Urdu		
DA	Danish	KN	Kannada	RW	Kinyarwanda	UZ	Uzbek		

Customizing the function settings (Continued)

Ethernet

See ⇨ page 27.

General

Parental Lock

HD DVD and DVD video discs equipped with the Parental Lock function have a predetermined limitation level. The limitation level or limitation method may differ depending on the disc. For example the whole contents of a disc may not be played back, or an extreme violent scene may be cut or replaced automatically by another scene.

Important

- Depending on discs, it may not be evident whether the disc is compatible with Parental Lock function. Make sure that Parental Lock function you set is activated correctly.

1 Enter a 4-digit password by using the number buttons, then press OK button.

When you use the player for the first time, set a new password of 4-digit. If you make a mistake entering your password, press CLEAR button before pressing OK button, and re-enter the correct password.

2 Set the details.

a) Select "On" or "Off" by pressing ▲ / ▼ buttons.

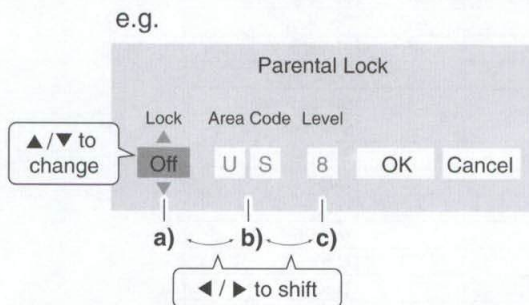

On

Select this to activate Parental Lock function or to change the setting.

Off

Deactivates the Parental Lock function. Skip b) and c) to go to 3.

b) Enter the code of a country/area whose standards were used to rate a disc, referring to the list below.

Country/Area	Code	Country/Area	Code	Country/Area	Code
AUSTRALIA	AU	INDONESIA	ID	SPAIN	ES
BELGIUM	BE	ITALY	IT	SWEDEN	BE
CANADA	CA	JAPAN	JP	SWITZERLAND	CH
CHINA	CN	MALAYSIA	MY	TAIWAN	TW
CHINA HONG KONG	HK	NETHERLANDS	NL	THAILAND	TH
DENMARK	DK	NORWAY	NO	UNITED KINGDOM	GB
FINLAND	FI	PHILIPPINES	PH	UNITED STATES	US
FRANCE	FR	RUSSIAN FEDERATION	RU		
GERMANY	DE	SINGAPORE	SG		

c) Select the desired limitation level.

Unless the Parental Lock function is set to "Off", a disc that has a higher limitation level than your selected limitation level cannot be played back. For example, if you select level 7, discs exceeding level 8 are locked and cannot be played back.

When "US" is selected, its limitation level corresponds to the following settings.

Level 7: NC-17 Level 6: R Level 4: PG13 Level 3: PG Level 1: G

3 Select "OK" then press OK button.

■ To change the limitation level of Parental Lock function

Follow steps 1 - 3 above.

■ To change the password

- At step 1, press ■ (STOP) button 4 times then press OK button.
The password is cleared.
- Enter a new 4-digit password by using the number buttons.
- Press OK button.

Clock Set

See ⇒ page 22.

OSD On/Off

To activate or deactivate the operational status display on the TV screen.

On	Activates the operational status display (e.g., ►) on the TV screen.
Off	Deactivates the operational status display (e.g., ►) on the TV screen.

Remote Controller Sound

To turn on or off the confirmation beeper announcing when each remote command is received.

On	Turns on the beep sound.
Off	Turns off the beep sound.

Screen Saver (North American models only)

Auto Power Off Turns the player off if stop mode or picture pausing continues for about 20 minutes.

On	Activates the screen saver if stop mode or picture pausing continues for about 20 minutes.
Off	Deactivates the screen saver.

Notes

- Onkyo does not guarantee that this function will protect your display.
- To close the screen saver, press any button on the player or the remote control.
- When an HD DVD disc is used, this function activates only in stop mode.

Maintenance

Initialize	To reset all the settings listed on ⇒ page 35, 36 to factory set default. Press ◀ / ▶ buttons to select "Yes" then press OK button.
Update (Firmware update)	If you have a broadband internet service, you may obtain firmware update over the internet using the ETHERNET port on the back of your player. <ul style="list-style-type: none">• BEFORE BEGINNING THE FIRMWARE UPDATE PROCESS, BE SURE TO REMOVE ANY DISCS FROM YOUR PLAYER.• Please configure the ETHERNET port (⇒ page 19). You may need to turn on DHCP and DNS (⇒ page 27).• Press SETUP and select "General" > "Maintenance". Follow the instructions on the screen.• If a firmware update is available for your player, the player will download it. Once the firmware update download process has finished, the player's power will automatically switch off. You must wait until this process has finished.• DO NOT UNPLUG, TURN OFF, OR USE ANY OTHER FEATURE OF YOUR PLAYER DURING THE FIRMWARE UPDATE PROCESS. Doing so will cause the writing of the firmware update to the player to be halted and the player may no longer operate properly. If the player stops working, please contact your Onkyo dealer.• If no firmware update is available, the player will quickly exit the firmware update process.
Persistent Storage	To open the menu to control player's memory allocated for content. (Not available while a disc is loaded.) The menu selections will vary depending on the content. Operate following the instructions displayed on your screen.

Twin Format Disc

To select a layer to play, HD DVD or DVD of an HD DVD Twin Format Disc. (Not available if a disc is loaded.)

HD DVD	Only the HD DVD layer is played.
DVD	Only the DVD layer is played.

Note

- For combination discs, select the desired version by disc side (see label for information).

Before calling service personnel

Before accessing, try updating this player's firmware. For details on how to update, see "Update (Firmware update)" (⇒ page 41).

If you experience any of the following difficulties while using this unit, check the list below before consulting your nearest Onkyo dealer.

Symptom	Remedy	Page
No power.	<ul style="list-style-type: none"> Is the power plug disconnected? Check the power connection. 	20
No picture.	<ul style="list-style-type: none"> Is the cable for connecting the player and TV disconnected or not connected properly? Check the connections. 	16
	<ul style="list-style-type: none"> Switch the input of the connected TV to the signal from the player. 	–
	<ul style="list-style-type: none"> Check the settings (MODE switch and "Resolution Setting"). 	24
	<ul style="list-style-type: none"> Are both the HDMI OUT jack and the COMPONENT VIDEO OUTPUT jacks connected simultaneously? Select either connection and make the appropriate setting. 	16
	<ul style="list-style-type: none"> In case the menu of "Resolution Setting" disappears, make composite video (yellow) connection to restore it, then select the resolution which is compatible with the connected TV. 	17, 23
No sound.	<ul style="list-style-type: none"> Is the audio cable disconnected? 	17
	<ul style="list-style-type: none"> Is the volume of the device turned down to the minimum level? Check the volume. 	–
	<ul style="list-style-type: none"> Switch the audio input of the device connected by the audio cable to the input from the player. 	–
	<ul style="list-style-type: none"> Set "Digital Out SPDIF" or "Digital Out HDMI" properly in accordance with the connected device and connection procedure. 	25
	<ul style="list-style-type: none"> Change the output resolution so that sound can be heard. 	23
	<ul style="list-style-type: none"> If using the optical digital output for a Dolby Digital Plus, Dolby TrueHD, DTS-HD or DTS soundtrack, be sure your AV receiver or processor is set to use the input connected to your player and is set to decode a DTS bitstream. If your AV receiver or processor does not support DTS, select PCM output on the player. 	25
Sounds of sub pictures such as commentaries and/or accessory sounds in menu operation cannot be heard.	<ul style="list-style-type: none"> "Digital Direct Audio Mode" > "On" is selected. To obtain these sounds, select "Off". 	37
The disc does not play.	<ul style="list-style-type: none"> Make sure the disc type can be played with the player. 	7
	<ul style="list-style-type: none"> Is the disc dirty or scratched? Check or clean the disc. 	7
	<ul style="list-style-type: none"> If the disc is a DVD-RW or DVD-R disc, finalize the disc before attempting to play it with the player. 	–
	<ul style="list-style-type: none"> If the disc includes parent lock support, playback is restricted while the parent lock of the player is set. Cancel Parental Lock or change the restriction level. 	40
Playback picture has noise.	<ul style="list-style-type: none"> If video from the player is watched via a video recorder or on a TV with a built-in video recorder, the copy guard may prevent images from being displayed properly. Be sure to connect the player directly to the TV. 	16
Playback picture does not move smoothly.	<ul style="list-style-type: none"> "Resolution Setting" > "up to 1080p/24Hz" is selected. Change the setting. 	23
The remote control does not work.	<ul style="list-style-type: none"> Are the batteries of the remote control dead? Replace the batteries. 	12
	<ul style="list-style-type: none"> Make sure the remote control is within range and pointed in the correct direction. 	12
Screen freezes and no buttons work.	<ul style="list-style-type: none"> Pressing ON/STANDBY button on the player for approximately ten seconds forces the player to turn off. Turn the player off and then on again. 	–
After powering on, "Clock Set" menu appears.	<ul style="list-style-type: none"> The power supply to the player may have been disconnected. Reset the clock. 	22

The DV-HD805 contains a microcomputer for signal processing and control functions. In very rare situations, severe interference, noise from an external source, or static electricity may cause it to lockup. In the unlikely even that this should happen, unplug the power cord from the wall outlet, wait at least five seconds, and then plug it back in again.

License information on the software used in the Onkyo HD DVD player

This document is statement purpose only. Not concerned with operation of this product.

The software pre-installed in the Onkyo HD DVD player consists of multiple, independent software components. Each software component is copyrighted by Onkyo or a third party.

The Onkyo HD DVD player uses software components that are distributed as freeware under a third-party end-user license agreement or copyright notice (hereinafter referred to as a "EULA").

Some EULAs require that the source code of the applicable component be disclosed as the condition for distributing the software component in executable format. Please contact your Onkyo dealer to check the software components subject to such EULA requirements.

Onkyo provides a warranty for the Onkyo HD DVD player you have purchased under conditions set forth by Onkyo.

However, some of the software components distributed under an EULA are made available for use by the user on the assumption that they are not copyrighted or warranted by Onkyo or any third party. These software components are licensed to the user free of charge and therefore not covered by any warranty within the scope of the applicable laws. These software components are not subject to any copyrights or other third-party rights and are provided in "as is" condition without any warranty, whether express or implied. "Warranty" here includes, but not limited to, an implied warranty for marketability or fitness for specific uses. All risks associated with the quality or performance of these software components are assumed by the user. Onkyo shall not be liable whatsoever for any cost of repair or correction or other incidental expense incurred in connection with a defect found in any of these software components. Unless specified under the applicable laws or in a written agreement, a party who changes or redistributes the software with consent from the copyright holders or based on the aforementioned licenses shall not be held liable whatsoever for any loss arising from the use of or inability to use such software components. The same applies even when the copyright holders or relevant third parties have been informed of the possibility of such loss. "Loss" here includes normal, special, incidental and indirect loss (including, but not limited to, the loss of data or its accuracy; loss incurred by the user or any third party; and interface incompatibility with other software). Please read each EULA for details on the use conditions and items that must be observed regarding these software components.

The table below lists the software components pre-installed in the Onkyo HD DVD player, which are subject to EULAs. The user should read the applicable EULAs carefully before using these software components. The EULAs are exhibited in their original text (English) as exactly written by the respective parties other than Onkyo

Pre-installed software	EULA	Pre-installed software	EULA
Linux Kernel Busybox	Exhibit A	OpenSSL	Exhibit C
glibc	Exhibit B	freetype	Exhibit D

Exhibit A

GNU GENERAL PUBLIC LICENSE Version 2, June 1991

Copyright © 1989, 1991 Free Software Foundation, Inc.
59 Temple Place, Suite 330, Boston, MA 02111-1307

USA

Everyone is permitted to copy and distribute verbatim copies of this license document, but changing it is not allowed.

Preamble

The licenses for most software are designed to take away your freedom to share and change it. By contrast, the GNU General Public License is intended to guarantee your freedom to share and change free software – to make sure the software is free for all its users. This General Public License applies to most of the Free Software Foundation's software and to any other program whose authors commit to using it. (Some other Free Software Foundation software is covered by the GNU Library General Public License instead.) You can apply it to your programs, too.

When we speak of free software, we are referring to freedom, not price. Our General Public Licenses are designed to make sure that you have the freedom to distribute copies of free software (and charge for this service if you wish), that you receive source code or can get it if you want it, that you can change the software or use pieces of it in new free programs; and that you know you can do these things.

To protect your rights, we need to make restrictions that forbid anyone to deny you these rights or to ask you to surrender the rights.

These restrictions translate to certain responsibilities for you if you distribute copies of the software, or if you modify it.

For example, if you distribute copies of such a program, whether gratis or for a fee, you must give the recipients all the rights that you have. You must make sure that they, too, receive or can get the source code. And you must show them these terms so they know their rights.

We protect your rights with two steps: (1) copyright the software, and (2) offer you this license which gives you legal permission to copy, distribute and/or modify the software.

Also, for each author's protection and ours, we want to make certain that everyone understands that there is no warranty for this free software. If the software is modified by someone else and passed on, we want its recipients to know that what they have is not the original, so that any problems introduced by others will not reflect on the original authors' reputations.

Finally, any free program is threatened constantly by software patents. We wish to avoid the danger that redistributors of a free program will individually obtain patent licenses, in effect making the program proprietary. To prevent this, we have made it clear that any patent must be licensed for everyone's free use or not licensed at all.

The precise terms and conditions for copying, distribution and modification follow.

License information on the software used in the Onkyo HD DVD player (Continued)

GNU GENERAL PUBLIC LICENSE TERMS AND CONDITIONS FOR COPYING, DISTRIBUTION AND MODIFICATION

0. This License applies to any program or other work which contains a notice placed by the copyright holder saying it may be distributed under the terms of this General Public License. The "Program", below, refers to any such program or work, and a "work based on the Program" means either the Program or any derivative work under copyright law: that is to say, a work containing the Program or a portion of it, either verbatim or with modifications and/or translated into another language. (Hereinafter, translation is included without limitation in the term "modification".) Each licensee is addressed as "you".

Activities other than copying, distribution and modification are not covered by this License; they are outside its scope. The act of running the Program is not restricted, and the output from the Program is covered only if its contents constitute a work based on the Program (independent of having been made by running the Program). Whether that is true depends on what the Program does.

1. You may copy and distribute verbatim copies of the Program's source code as you receive it, in any medium, provided that you conspicuously and appropriately publish on each copy an appropriate copyright notice and disclaimer of warranty; keep intact all the notices that refer to this License and to the absence of any warranty; and give any other recipients of the Program a copy of this License along with the Program.

You may charge a fee for the physical act of transferring a copy, and you may at your option offer warranty protection in exchange for a fee.

2. You may modify your copy or copies of the Program or any portion of it, thus forming a work based on the Program, and copy and distribute such modifications or work under the terms of Section 1 above, provided that you also meet all of these conditions:

- a) You must cause the modified files to carry prominent notices stating that you changed the files and the date of any change.
- b) You must cause any work that you distribute or publish, that in whole or in part contains or is derived from the Program or any part thereof, to be licensed as a whole at no charge to all third parties under the terms of this License.
- c) If the modified program normally reads commands interactively when run, you must cause it, when started running for such interactive use in the most ordinary way, to print or display an announcement including an appropriate copyright notice and a notice that there is no warranty (or else, saying that you provide a warranty) and that users may redistribute the program under these conditions, and telling the user how to view a copy of this License.

(Exception: if the Program itself is interactive but does not normally print such an announcement, your work based on the Program is not required to print an announcement.)

These requirements apply to the modified work as a whole. If identifiable sections of that work are not derived from the Program, and can be reasonably considered independent and separate works in themselves, then this License, and its terms, do not apply to those sections when you distribute them as separate works. But when you distribute the same sections as part of a whole which is a work based on the Program, the distribution of the whole must be on the terms of this License, whose permissions for other licensees extend to the entire whole, and thus to each and every part regardless of who wrote it.

Thus, it is not the intent of this section to claim rights or contest your rights to work written entirely by you; rather, the intent is to exercise the right to control the distribution of derivative or collective works based on the Program.

In addition, mere aggregation of another work not based on the Program with the Program (or with a work based on the Program) on a volume of a storage or distribution medium does not bring the other work under the scope of this License.

3. You may copy and distribute the Program (or a work based on it, under Section 2) in object code or executable form under the terms of Sections 1 and 2 above provided that you also do one of the following:

- a) Accompany it with the complete corresponding machine-readable source code, which must be distributed under the terms of Sections 1 and 2 above on a medium customarily used for software interchange; or,
- b) Accompany it with a written offer, valid for at least three years, to give any third party, for a charge no more than your cost of physically performing source distribution, a complete machine-readable copy of the corresponding source code, to be distributed under the terms of Sections 1 and 2 above on a medium customarily used for software interchange; or,
- c) Accompany it with the information you received as to the offer to distribute corresponding source code. (This alternative is allowed only for noncommercial distribution and only if you received the program in object code or executable form with such an offer, in accord with Subsection b above.)

The source code for a work means the preferred form of the work for making modifications to it. For an executable work, complete source code means all the source code for all modules it contains, plus any associated interface definition files, plus the scripts used to control compilation and installation of the executable. However, as a special exception, the source code distributed need not include anything that is normally distributed (in either source or binary form) with the major components (compiler, kernel, and so on) of the operating system on which the executable runs, unless that component itself accompanies the executable.

If distribution of executable or object code is made by offering access to copy from a designated place, then offering equivalent access to copy the source code from the same place counts as distribution of the source code, even though third parties are not compelled to copy the source along with the object code.

4. You may not copy, modify, sublicense, or distribute the Program except as expressly provided under this License. Any attempt otherwise to copy, modify, sublicense or distribute the Program is void, and will automatically terminate your rights under this License. However, parties who have received copies, or rights, from you under this License will not have their licenses terminated so long as such parties remain in full compliance.

5. You are not required to accept this License, since you have not signed it. However, nothing else grants you permission to modify or distribute the Program or its derivative works. These actions are prohibited by law if you do not accept this License. Therefore, by modifying or distributing the Program (or any work based on the Program), you indicate your acceptance of this License to do so, and all its terms and conditions for copying, distributing or modifying the Program or works based on it.

6. Each time you redistribute the Program (or any work based on the Program), the recipient automatically receives a license from the original licensor to copy, distribute or modify the Program subject to these terms and conditions. You may not impose any further restrictions on the recipients' exercise of the rights granted herein. You are not responsible for enforcing compliance by third parties to this License.

7. If as a consequence of a court judgment or allegation of patent infringement or for any other reason (not limited to patent issues), conditions are imposed on you (whether by court order, agreement or otherwise) that contradict the conditions of this License, they do not excuse you from the conditions of this License. If you cannot distribute so as to satisfy simultaneously your obligations under this License and any other pertinent obligations, then as a consequence you may not distribute the Program at all.

For example, if a patent license would not permit royalty-free redistribution of the Program by all those who receive copies directly or indirectly through you, then the only way you could satisfy both it and this License would be to refrain entirely from distribution of the Program. If any portion of this section is held invalid or unenforceable under any particular circumstance, the balance of the section is intended to apply and the section as a whole is intended to apply in other circumstances.

It is not the purpose of this section to induce you to infringe any patents or other property right claims or to contest validity of any such claims; this section has the sole purpose of protecting the integrity of the free software distribution system, which is implemented by public license practices. Many people have made generous contributions to the wide range of software distributed through that system in reliance on consistent application of that system; it is up to the author/donor to decide if he or she is willing to distribute software through any other system and a licensee cannot impose that choice.

This section is intended to make thoroughly clear what is believed to be a consequence of the rest of this License.

8.If the distribution and/or use of the Program is restricted in certain countries either by patents or by copyrighted interfaces, the original copyright holder who places the Program under this License may add an explicit geographical distribution limitation excluding those countries, so that distribution is permitted only in or among countries not thus excluded. In such case, this License incorporates the limitation as if written in the body of this License.

9.The Free Software Foundation may publish revised and/or new versions of the General Public License from time to time. Such new versions will be similar in spirit to the present version, but may differ in detail to address new problems or concerns.

Each version is given a distinguishing version number. If the Program specifies a version number of this License which applies to it and "any later version", you have the option of following the terms and conditions either of that version or of any later version published by the Free Software Foundation. If the Program does not specify a version number of this License, you may choose any version ever published by the Free Software Foundation.

10.If you wish to incorporate parts of the Program into other free programs whose distribution conditions are different, write to the author to ask for permission. For software which is copyrighted by the Free Software Foundation, write to the Free Software Foundation; we sometimes make exceptions for this. Our decision will be guided by the two goals of preserving the free status of all derivatives of our free software and of promoting the sharing and reuse of software generally.

NO WARRANTY

11.BECAUSE THE PROGRAM IS LICENSED FREE OF CHARGE, THERE IS NO WARRANTY FOR THE PROGRAM, TO THE EXTENT PERMITTED BY APPLICABLE LAW. EXCEPT WHEN OTHERWISE STATED IN WRITING THE COPYRIGHT HOLDERS AND/OR OTHER PARTIES PROVIDE THE PROGRAM "AS IS" WITHOUT WARRANTY OF ANY KIND, EITHER EXPRESSED OR IMPLIED, INCLUDING, BUT NOT LIMITED TO, THE IMPLIED WARRANTIES OF MERCHANTABILITY AND FITNESS FOR A PARTICULAR PURPOSE. THE ENTIRE RISK AS TO THE QUALITY AND PERFORMANCE OF THE PROGRAM IS WITH YOU. SHOULD THE PROGRAM PROVE DEFECTIVE, YOU ASSUME THE COST OF ALL NECESSARY SERVICING, REPAIR OR CORRECTION.

12.IN NO EVENT UNLESS REQUIRED BY APPLICABLE LAW OR AGREED TO IN WRITING WILL ANY COPYRIGHT HOLDER, OR ANY OTHER PARTY WHO MAY MODIFY AND/OR REDISTRIBUTE THE PROGRAM AS PERMITTED ABOVE, BE LIABLE TO YOU FOR DAMAGES, INCLUDING ANY GENERAL, SPECIAL, INCIDENTAL OR CONSEQUENTIAL DAMAGES ARISING OUT OF THE USE OR INABILITY TO USE THE PROGRAM (INCLUDING BUT NOT LIMITED TO LOSS OF DATA OR DATA BEING RENDERED INACCURATE OR LOSSES SUSTAINED BY YOU OR THIRD PARTIES OR A FAILURE OF THE PROGRAM TO OPERATE WITH ANY OTHER PROGRAMS), EVEN IF SUCH HOLDER OR OTHER PARTY HAS BEEN ADVISED OF THE POSSIBILITY OF SUCH DAMAGES.

END OF TERMS AND CONDITIONS

How to Apply These Terms to Your New Programs

If you develop a new program, and you want it to be of the greatest possible use to the public, the best way to achieve this is to make it free software which everyone can redistribute and change under these terms.

To do so, attach the following notices to the program. It is safest to attach them to the start of each source file to most effectively convey the exclusion of warranty; and each file should have at least the "copyright" line and a pointer to where the full notice is found.

<One line to give the program's name and a brief idea of what it does.>

Copyright © 19yy <name of author>

This program is free software; you can redistribute it and/or modify it under the terms of the GNU General Public License as published by the Free Software Foundation; either version 2 of the License, or (at your option) any later version.

This program is distributed in the hope that it will be useful, but WITHOUT ANY WARRANTY; without even the implied warranty of MERCHANTABILITY or FITNESS FOR A PARTICULAR PURPOSE. See the GNU General Public License for more details.

You should have received a copy of the GNU General Public License along with this program; if not, write to the Free Software Foundation, Inc., 59 Temple Place, Suite 330, Boston, MA 02111-1307 USA

Also add information on how to contact you by electronic and paper mail.

If the program is interactive, make it output a short notice like this when it starts in an interactive mode:

Gnomovision version 69, Copyright © 19yy name of author
Gnomovision comes with ABSOLUTELY NO WARRANTY;
for details type `show w'. This is free software, and you are
welcome to redistribute it under certain conditions; type `show
c' for details.

The hypothetical commands `show w' and `show c' should show the appropriate parts of the General Public License. Of course, the commands you use may be called something other than `show w' and `show c'; they could even be mouse-clicks or menu items – whatever suits your program.

You should also get your employer (if you work as a programmer) or your school, if any, to sign a "copyright disclaimer" for the program; if necessary. Here is a sample; alter the names:

Yoyodyne, Inc., hereby disclaims all copyright interest in the
program `Gnomovision' (which makes passes at compilers)
written by James Hacker.

<signature of Ty Coon>, 1 April 1989 Ty Coon, President of Vice

This General Public License does not permit incorporating your program into proprietary programs. If your program is a subroutine library, you may consider it more useful to permit linking proprietary applications with the library. If this is what you want to do, use the GNU Library General Public License instead of this License.

License information on the software used in the Onkyo HD DVD player (Continued)

Exhibit B

GNU LESSER GENERAL PUBLIC LICENSE Version 2.1, February 1999

Copyright © 1991, 1999 Free Software Foundation, Inc. 59 Temple Place, Suite 330, Boston, MA 02111-1307 USA Everyone is permitted to copy and distribute verbatim copies of this license document, but changing it is not allowed.

[This is the first released version of the Lesser GPL. It also counts as the successor of the GNU Library Public License, version 2, hence the version number 2.1.]

Preamble

The licenses for most software are designed to take away your freedom to share and change it. By contrast, the GNU General Public Licenses are intended to guarantee your freedom to share and change free software – to make sure the software is free for all its users.

This license, the Lesser General Public License, applies to some specially designated software packages – typically libraries – of the Free Software Foundation and other authors who decide to use it. You can use it too, but we suggest you first think carefully about whether this license or the ordinary General Public License is the better strategy to use in any particular case, based on the explanations below.

When we speak of free software, we are referring to freedom of use, not price. Our General Public Licenses are designed to make sure that you have the freedom to distribute copies of free software (and charge for this service if you wish); that you receive source code or can get it if you want it; that you can change the software and use pieces of it in new free programs; and that you are informed that you can do these things.

To protect your rights, we need to make restrictions that forbid distributors to deny you these rights or to ask you to surrender these rights. These restrictions translate to certain responsibilities for you if you distribute copies of the library or if you modify it.

For example, if you distribute copies of the library, whether gratis or for a fee, you must give the recipients all the rights that we gave you. You must make sure that they, too, receive or can get the source code. If you link other code with the library, you must provide complete object files to the recipients, so that they can relink them with the library after making changes to the library and recompiling it. And you must show them these terms so they know their rights.

We protect your rights with a two-step method: (1) we copyright the library, and (2) we offer you this license, which gives you legal permission to copy, distribute and/or modify the library.

To protect each distributor, we want to make it very clear that there is no warranty for the free library. Also, if the library is modified by someone else and passed on, the recipients should know that what they have is not the original version, so that the original author's reputation will not be affected by problems that might be introduced by others.

Finally, software patents pose a constant threat to the existence of any free program. We wish to make sure that a company cannot effectively restrict the users of a free program by obtaining a restrictive license from a patent holder. Therefore, we insist that any patent license obtained for a version of the library must be consistent with the full freedom of use specified in this license.

Most GNU software, including some libraries, is covered by the ordinary GNU General Public License. This license, the GNU Lesser General Public License, applies to certain designated libraries, and is quite different from the ordinary General Public License. We use this license for certain libraries in order to permit linking those libraries into non-free programs.

When a program is linked with a library, whether statically or using a shared library, the combination of the two is legally speaking a combined work, a derivative of the original library. The ordinary General Public License therefore permits such linking only if the entire combination fits its criteria of freedom. The Lesser General Public License permits more lax criteria for linking other code with the library.

We call this license the "Lesser" General Public License because it does Less to protect the user's freedom than the ordinary General Public License. It also provides other free software developers Less of an advantage over competing non-free programs. These disadvantages are the reason we use the ordinary General Public License for many libraries. However, the Lesser license provides advantages in certain special circumstances.

For example, on rare occasions, there may be a special need to encourage the widest possible use of a certain library, so that it becomes a de-facto standard. To achieve this, non-free programs must be allowed to use the library. A more frequent case is that a free library does the same job as widely used non-free libraries. In this case, there is little to gain by limiting the free library to free software only, so we use the Lesser General Public License.

In other cases, permission to use a particular library in non-free programs enables a greater number of people to use a large body of free software. For example, permission to use the GNU C Library in non-free programs enables many more people to use the whole GNU operating system, as well as its variant, the GNU/Linux operating system.

Although the Lesser General Public License is Less protective of the users' freedom, it does ensure that the user of a program that is linked with the Library has the freedom and the wherewithal to run that program using a modified version of the Library.

The precise terms and conditions for copying, distribution and modification follow. Pay close attention to the difference between a "work based on the library" and a "work that uses the library". The former contains code derived from the library, whereas the latter must be combined with the library in order to run.

GNU LESSER GENERAL PUBLIC LICENSE TERMS AND CONDITIONS FOR COPYING, DISTRIBUTION AND MODIFICATION

0. This License Agreement applies to any software library or other program which contains a notice placed by the copyright holder or other authorized party saying it may be distributed under the terms of this Lesser General Public License (also called "this License"). Each licensee is addressed as "you".

A "library" means a collection of software functions and/or data prepared so as to be conveniently linked with application programs (which use some of those functions and data) to form executables.

The "Library", below, refers to any such software library or work which has been distributed under these terms. A "work based on the Library" means either the Library or any derivative work under copyright law: that is to say, a work containing the Library or a portion of it, either verbatim or with modifications and/or translated straightforwardly into another language. (Hereinafter, translation is included without limitation in the term "modification".)

"Source code" for a work means the preferred form of the work for making modifications to it. For a library, complete source code means all the source code for all modules it contains, plus any associated interface definition files, plus the scripts used to control compilation and installation of the library.

Activities other than copying, distribution and modification are not covered by this License; they are outside its scope. The act of running a program using the Library is not restricted, and output from such a program is covered only if its contents constitute a work based on the Library (independent of the use of the Library in a tool for writing it). Whether that is true depends on what the Library does and what the program that uses the Library does.

1. You may copy and distribute verbatim copies of the Library's complete source code as you receive it, in any medium, provided that you conspicuously and appropriately publish on each copy an appropriate copyright notice and disclaimer of warranty; keep intact all the notices that refer to this License and to the absence of any warranty; and distribute a copy of this License along with the Library.

You may charge a fee for the physical act of transferring a copy, and you may at your option offer warranty protection in exchange for a fee.

2. You may modify your copy or copies of the Library or any portion of it, thus forming a work based on the Library, and copy and distribute such modifications or work under the terms of Section 1 above, provided that you also meet all of these conditions:

- a) The modified work must itself be a software library.
- b) You must cause the files modified to carry prominent notices stating that you changed the files and the date of any change.
- c) You must cause the whole of the work to be licensed at no charge to all third parties under the terms of this License.
- d) If a facility in the modified Library refers to a function or a table of data to be supplied by an application program that uses the facility, other than as an argument passed when the facility is invoked, then you must make a good faith effort to ensure that, in the event an application does not supply such function or table, the facility still operates, and performs whatever part of its purpose remains meaningful.

(For example, a function in a library to compute square roots has a purpose that is entirely welldefined independent of the application. Therefore, Subsection 2d requires that any applicationsupplied function or table used by this function must be optional: if the application does not supply it, the square root function must still compute square roots.)

These requirements apply to the modified work as a whole. If identifiable sections of that work are not derived from the Library, and can be reasonably considered independent and separate works in themselves, then this License, and its terms, do not apply to those sections when you distribute them as separate works. But when you distribute the same sections as part of a whole which is a work based on the Library, the distribution of the whole must be on the terms of this License, whose permissions for other licensees extend to the entire whole, and thus to each and every part regardless of who wrote it.

Thus, it is not the intent of this section to claim rights or contest your rights to work written entirely by you; rather, the intent is to exercise the right to control the distribution of derivative or collective works based on the Library.

In addition, mere aggregation of another work not based on the Library with the Library (or with a work based on the Library) on a volume of a storage or distribution medium does not bring the other work under the scope of this License.

3. You may opt to apply the terms of the ordinary GNU General Public License instead of this License to a given copy of the Library. To do this, you must alter all the notices that refer to this License, so that they refer to the ordinary GNU General Public License, version 2, instead of to this License. (If a newer version than version 2 of the ordinary GNU General Public License has appeared, then you can specify that version instead if you wish.) Do not make any other change in these notices.

Once this change is made in a given copy, it is irreversible for that copy, so the ordinary GNU General Public License applies to all subsequent copies and derivative works made from that copy.

This option is useful when you wish to copy part of the code of the Library into a program that is not a library.

4. You may copy and distribute the Library (or a portion or derivative of it, under Section 2) in object code or executable form under the terms of Sections 1 and 2 above provided that you accompany it with the complete corresponding machine-readable source code, which must be distributed under the terms of Sections 1 and 2 above on a medium customarily used for software interchange.

If distribution of object code is made by offering access to copy from a designated place, then offering equivalent access to copy the source code from the same place satisfies the requirement to distribute the source code, even though third parties are not compelled to copy the source along with the object code.

5. A program that contains no derivative of any portion of the Library, but is designed to work with the Library by being compiled or linked with it, is called a "work that uses the Library". Such a work, in isolation, is not a derivative work of the Library, and therefore falls outside the scope of this License.

However, linking a "work that uses the Library" with the Library creates an executable that is a derivative of the Library (because it contains portions of the Library), rather than a "work that uses the library". The executable is therefore covered by this License. Section 6 states terms for distribution of such executables.

When a "work that uses the Library" uses material from a header file that is part of the Library, the object code for the work may be a derivative work of the Library even though the source code is not. Whether this is true is especially significant if the work can be linked without the Library, or if the work is itself a library. The threshold for this to be true is not precisely defined by law.

If such an object file uses only numerical parameters, data structure layouts and accessors, and small macros and small inline functions (ten lines or less in length), then the use of the object file is unrestricted, regardless of whether it is legally a derivative work. (Executables containing this object code plus portions of the Library will still fall under Section 6.)

Otherwise, if the work is a derivative of the Library, you may distribute the object code for the work under the terms of Section 6. Any executables containing that work also fall under Section 6, whether or not they are linked directly with the Library itself.

6. As an exception to the Sections above, you may also combine or link a "work that uses the Library" with the Library to produce a work containing portions of the Library, and distribute that work under terms of your choice, provided that the terms permit modification of the work for the customer's own use and reverse engineering for debugging such modifications.

You must give prominent notice with each copy of the work that the Library is used in it and that the Library and its use are covered by this License. You must supply a copy of this License. If the work during execution displays copyright notices, you must include the copyright notice for the Library among them, as well as a reference directing the user to the copy of this License. Also, you must do one of these things:

- a) Accompany the work with the complete corresponding machine-readable source code for the Library including whatever changes were used in the work (which must be distributed under Sections 1 and 2 above); and, if the work is an executable linked with the Library, with the complete machine-readable "work that uses the Library", as object code and/or source code, so that the user can modify the Library and then relink to produce a modified executable containing the modified Library. (It is understood that the user who changes the contents of definitions files in the Library will not necessarily be able to recompile the application to use the modified definitions.)
- b) Use a suitable shared library mechanism for linking with the Library. A suitable mechanism is one that (1) uses at run time a copy of the library already present on the user's computer system, rather than copying library functions into the executable, and (2) will operate properly with a modified version of the library, if the user installs one, as long as the modified version is interface-compatible with the version that the work was made with.
- c) Accompany the work with a written offer, valid for at least three years, to give the same user the materials specified in Subsection 6a, above, for a charge no more than the cost of performing this distribution.
- d) If distribution of the work is made by offering access to copy from a designated place, offer equivalent access to copy the above specified materials from the same place.
- e) Verify that the user has already received a copy of these materials or that you have already sent this user a copy.

For an executable, the required form of the "work that uses the Library" must include any data and utility programs needed for reproducing the executable from it. However, as a special exception, the materials to be distributed need not include anything that is normally distributed (in either source or binary form) with the major components (compiler, kernel, and so on) of the operating system on which the executable runs, unless that component itself accompanies the executable.

It may happen that this requirement contradicts the license restrictions of other proprietary libraries that do not normally accompany the operating system. Such a contradiction means you cannot use both them and the Library together in an executable that you distribute.

7. You may place library facilities that are a work based on the Library side-by-side in a single library together with other library facilities not covered by this License, and distribute such a combined library, provided that the separate distribution of the work based on the Library and of the other library facilities is otherwise permitted, and provided that you do these two things:

License information on the software used in the Onkyo HD DVD player (Continued)

- a) Accompany the combined library with a copy of the same work based on the Library, uncombined with any other library facilities. This must be distributed under the terms of the Sections above.
- b) Give prominent notice with the combined library of the fact that part of it is a work based on the Library, and explaining where to find the accompanying uncombined form of the same work.

8. You may not copy, modify, sublicense, link with, or distribute the Library except as expressly provided under this License. Any attempt otherwise to copy, modify, sublicense, link with, or distribute the Library is void, and will automatically terminate your rights under this License. However, parties who have received copies, or rights, from you under this License will not have their licenses terminated so long as such parties remain in full compliance.

9. You are not required to accept this License, since you have not signed it. However, nothing else grants you permission to modify or distribute the Library or its derivative works. These actions are prohibited by law if you do not accept this License. Therefore, by modifying or distributing the Library (or any work based on the Library), you indicate your acceptance of this License to do so, and all its terms and conditions for copying, distributing or modifying the Library or works based on it.

10. Each time you redistribute the Library (or any work based on the Library), the recipient automatically receives a license from the original licensor to copy, distribute, link with or modify the Library subject to these terms and conditions. You may not impose any further restrictions on the recipients' exercise of the rights granted herein. You are not responsible for enforcing compliance by third parties with this License.

11. If, as a consequence of a court judgment or allegation of patent infringement or for any other reason (not limited to patent issues), conditions are imposed on you (whether by court order, agreement or otherwise) that contradict the conditions of this License, they do not excuse you from the conditions of this License. If you cannot distribute so as to satisfy simultaneously your obligations under this License and any other pertinent obligations, then as a consequence you may not distribute the Library at all. For example, if a patent license would not permit royalty-free redistribution of the Library by all those who receive copies directly or indirectly through you, then the only way you could satisfy both it and this License would be to refrain entirely from distribution of the Library.

If any portion of this section is held invalid or unenforceable under any particular circumstance, the balance of the section is intended to apply, and the section as a whole is intended to apply in other circumstances.

It is not the purpose of this section to induce you to infringe any patents or other property right claims or to contest validity of any such claims; this section has the sole purpose of protecting the integrity of the free software distribution system which is implemented by public license practices. Many people have made generous contributions to the wide range of software distributed through that system in reliance on consistent application of that system; it is up to the author/donor to decide if he or she is willing to distribute software through any other system and a licensee cannot impose that choice.

This section is intended to make thoroughly clear what is believed to be a consequence of the rest of this License.

12. If the distribution and/or use of the Library is restricted in certain countries either by patents or by copyrighted interfaces, the original copyright holder who places the Library under this License may add an explicit geographical distribution limitation excluding those countries, so that distribution is permitted only in or among countries not thus excluded. In such case, this License incorporates the limitation as if written in the body of this License.

13. The Free Software Foundation may publish revised and/or new versions of the Lesser General Public License from time to time. Such new versions will be similar in spirit to the present version, but may differ in detail to address new problems or concerns. Each version is given a distinguishing version number. If the Library specifies a version number of this License which applies to it and "any later version", you have the option of following the terms and conditions either of that version or of any later version published by the Free Software Foundation. If the Library does not specify a license version number, you may choose any version ever published by the Free Software Foundation.

14. If you wish to incorporate parts of the Library into other free programs whose distribution conditions are incompatible with these, write to the author to ask for permission. For software which is copyrighted by the Free Software Foundation, write to the Free Software Foundation; we sometimes make exceptions for this. Our decision will be guided by the two goals of preserving the free status of all derivatives of our free software and of promoting the sharing and reuse of software generally.

NO WARRANTY

15. BECAUSE THE LIBRARY IS LICENSED FREE OF CHARGE, THERE IS NO WARRANTY FOR THE LIBRARY, TO THE EXTENT PERMITTED BY APPLICABLE LAW. EXCEPT WHEN OTHERWISE STATED IN WRITING THE COPYRIGHT HOLDERS AND/OR OTHER PARTIES PROVIDE THE LIBRARY "AS IS" WITHOUT WARRANTY OF ANY KIND, EITHER EXPRESSED OR IMPLIED, INCLUDING, BUT NOT LIMITED TO, THE IMPLIED WARRANTIES OF MERCHANTABILITY AND FITNESS FOR A PARTICULAR PURPOSE. THE ENTIRE RISK AS TO THE QUALITY AND PERFORMANCE OF THE LIBRARY IS WITH YOU. SHOULD THE LIBRARY PROVE DEFECTIVE, YOU ASSUME THE COST OF ALL NECESSARY SERVICING, REPAIR OR CORRECTION.

16. IN NO EVENT UNLESS REQUIRED BY APPLICABLE LAW OR AGREED TO IN WRITING WILL ANY COPYRIGHT HOLDER, OR ANY OTHER PARTY WHO MAY MODIFY AND/OR REDISTRIBUTE THE LIBRARY AS PERMITTED ABOVE, BE LIABLE TO YOU FOR DAMAGES, INCLUDING ANY GENERAL, SPECIAL, INCIDENTAL OR CONSEQUENTIAL DAMAGES ARISING OUT OF THE USE OR INABILITY TO USE THE LIBRARY (INCLUDING BUT NOT LIMITED TO LOSS OF DATA OR DATA BEING RENDERED INACCURATE OR LOSSES SUSTAINED BY YOU OR THIRD PARTIES OR A FAILURE OF THE LIBRARY TO OPERATE WITH ANY OTHER SOFTWARE), EVEN IF SUCH HOLDER OR OTHER PARTY HAS BEEN ADVISED OF THE POSSIBILITY OF SUCH DAMAGES.

END OF TERMS AND CONDITIONS

How to Apply These Terms to Your New Libraries

If you develop a new library, and you want it to be of the greatest possible use to the public, we recommend making it free software that everyone can redistribute and change. You can do so by permitting redistribution under these terms (or, alternatively, under the terms of the ordinary General Public License).

To apply these terms, attach the following notices to the library. It is safest to attach them to the start of each source file to most effectively convey the exclusion of warranty; and each file should have at least the "copyright" line and a pointer to where the full notice is found.

<one line to give the library's name and a brief idea of what it does.>

Copyright © <year> <name of author>

This library is free software; you can redistribute it and/or modify it under the terms of the GNU Lesser General Public License as published by the Free Software Foundation; either version 2 of the License, or (at your option) any later version.

This library is distributed in the hope that it will be useful, but WITHOUT ANY WARRANTY; without even the implied warranty of MERCHANTABILITY or FITNESS FOR A PARTICULAR PURPOSE. See the GNU Lesser General Public License for more details.

You should have received a copy of the GNU Lesser General Public License along with this library; if not, write to the Free Software Foundation, Inc., 59 Temple Place, Suite 330, Boston, MA 02111-1307 USA

Also add information on how to contact you by electronic and paper mail.

You should also get your employer (if you work as a programmer) or your school, if any, to sign a "copyright disclaimer" for the library, if necessary. Here is a sample; alter the names: Yoyodyne, Inc., hereby disclaims all copyright interest in the library 'Frob' (a library for tweaking knobs) written by James Random Hacker.

<signature of Ty Coon>, 1 April 1990

Ty Coon, President of Vice

That's all there is to it!

Exhibit C

LICENSE ISSUES

The OpenSSL toolkit stays under a dual license, i.e. both the conditions of the OpenSSL License and the original SSLeay license apply to the toolkit.

See below for the actual license texts. Actually both licenses are BSD-style Open Source licenses. In case of any license issues related to OpenSSL please contact openssl-core@openssl.org.

OpenSSL License

Copyright © 1998-2002 The OpenSSL Project. All rights reserved.

Redistribution and use in source and binary forms, with or without modification, are permitted provided that the following conditions are met:

1. Redistributions of source code must retain the above copyright notice, this list of conditions and the following disclaimer.
2. Redistributions in binary form must reproduce the above copyright notice, this list of conditions and the following disclaimer in the documentation and/or other materials provided with the distribution.
3. All advertising materials mentioning features or use of this software must display the following acknowledgment:

"This product includes software developed by the OpenSSL Project for use in the OpenSSL Toolkit. (<http://www.openssl.org/>)"

4. The names "OpenSSL Toolkit" and "OpenSSL Project" must not be used to endorse or promote products derived from this software without prior written permission. For written permission, please contact openssl-core@openssl.org.

5. Products derived from this software may not be called "OpenSSL" nor may "OpenSSL" appear in their names without prior written permission of the OpenSSL Project.

6. Redistributions of any form whatsoever must retain the following acknowledgment:

"This product includes software developed by the OpenSSL Project for use in the OpenSSL Toolkit (<http://www.openssl.org/>)"

THIS SOFTWARE IS PROVIDED BY THE OpenSSL PROJECT "AS IS" AND ANY EXPRESSED OR IMPLIED WARRANTIES, INCLUDING, BUT NOT LIMITED TO, THE IMPLIED WARRANTIES OF MERCHANTABILITY AND FITNESS FOR A PARTICULAR PURPOSE ARE DISCLAIMED. IN NO EVENT SHALL THE OpenSSL PROJECT OR ITS CONTRIBUTORS BE LIABLE FOR ANY DIRECT, INDIRECT, INCIDENTAL, SPECIAL, EXEMPLARY, OR CONSEQUENTIAL DAMAGES (INCLUDING, BUT NOT LIMITED TO, PROCUREMENT OF SUBSTITUTE GOODS OR SERVICES; LOSS OF USE, DATA, OR PROFITS; OR BUSINESS INTERRUPTION)

HOWEVER CAUSED AND ON ANY THEORY OF LIABILITY, WHETHER IN CONTRACT, STRICT LIABILITY, OR TORT (INCLUDING NEGLIGENCE OR OTHERWISE) ARISING IN ANY WAY OUT OF THE USE OF THIS SOFTWARE, EVEN IF ADVISED OF THE POSSIBILITY OF SUCH DAMAGE.

This product includes cryptographic software written by Eric Young (ey@cryptsoft.com). This product includes software written by Tim Hudson (tjh@cryptsoft.com).

Original SSLeay License

Copyright © 1995-1998 Eric Young (ey@cryptsoft.com) All rights reserved.

This package is an SSL implementation written by Eric Young (ey@cryptsoft.com).

The implementation was written so as to conform with Netscape's SSL.

This library is free for commercial and non-commercial use as long as the following conditions are adhered to. The following conditions apply to all code found in this distribution, be it the RC4, RSA, lhash, DES, etc., code; not just the SSL code. The SSL documentation included with this distribution is covered by the same copyright terms except that the holder is Tim Hudson (tjh@cryptsoft.com).

Copyright remains Eric Young's, and as such any Copyright notices in the code are not to be removed.

If this package is used in a product, Eric Young should be given attribution as the author of the parts of the library used.

This can be in the form of a textual message at program startup or in documentation (online or textual) provided with the package.

Redistribution and use in source and binary forms, with or without modification, are permitted provided that the following conditions are met:

1. Redistributions of source code must retain the copyright notice, this list of conditions and the following disclaimer.
2. Redistributions in binary form must reproduce the above copyright notice, this list of conditions and the following disclaimer in the documentation and/or other materials provided with the distribution.
3. All advertising materials mentioning features or use of this software must display the following acknowledgement:

"This product includes cryptographic software written by Eric Young (ey@cryptsoft.com)"

The word 'cryptographic' can be left out if the routines from the library being used are not cryptographic related :-).

4. If you include any Windows specific code (or a derivative thereof) from the apps directory (application code) you must include an acknowledgement:

"This product includes software written by Tim Hudson (tjh@cryptsoft.com)"

THIS SOFTWARE IS PROVIDED BY ERIC YOUNG "AS IS" AND ANY EXPRESS OR IMPLIED WARRANTIES, INCLUDING, BUT NOT LIMITED TO, THE IMPLIED WARRANTIES OF MERCHANTABILITY AND FITNESS FOR A PARTICULAR PURPOSE ARE DISCLAIMED. IN NO EVENT SHALL THE AUTHOR OR CONTRIBUTORS BE LIABLE FOR ANY DIRECT, INDIRECT, INCIDENTAL, SPECIAL, EXEMPLARY, OR CONSEQUENTIAL DAMAGES (INCLUDING, BUT NOT LIMITED TO, PROCUREMENT OF SUBSTITUTE GOODS OR SERVICES; LOSS OF USE, DATA, OR PROFITS; OR BUSINESS INTERRUPTION) HOWEVER CAUSED AND ON ANY THEORY OF LIABILITY, WHETHER IN CONTRACT, STRICT LIABILITY, OR TORT (INCLUDING NEGLIGENCE OR OTHERWISE) ARISING IN ANY WAY OUT OF THE USE OF THIS SOFTWARE, EVEN IF ADVISED OF THE POSSIBILITY OF SUCH DAMAGE.

The licence and distribution terms for any publically available version or derivative of this code cannot be changed. i.e. this code cannot simply be copied and put under another distribution licence [including the GNU Public Licence.]

Exhibit D

Portions of this software are copyright © 2005 The FreeType Project (www.freetype.org). All rights reserved.

- This product includes software developed by the OpenSSL project.
- Reverse engineering, disassembling, decompiling, dismantling, or otherwise attempting to analyze or modify the software included in this product is prohibited.

Specification

■ Power requirement

North American Models: 47.0W
European Models: 50.0W

■ Power supply

North American: 120V AC 60Hz
European: 220 - 240V AC 50/60Hz

■ Mass

4.3kg

■ External dimension

Width 435 x Height 73 x Depth 346mm
(17-1/8" x 2-7/8" x 13-5/8")

■ Signal system

North American Models:
Standard NTSC Color TV system
European Models:
Standard PAL/NTSC Color system

■ Laser

Semiconductor laser
Wavelength: 405nm/650nm/780nm

■ VIDEO output

1.0Vp-p (75Ω), Sync signal negative,
Pin jack x 1 system

■ S VIDEO output

(Y) 1.0Vp-p (75Ω), Sync signal negative,
(C) 0.286Vp-p (75Ω), 1 at rear
Mini DIN4 Pin x 1 system

■ Component output (Y, P_B, P_R)

Y output (green), 1.0Vp-p (75Ω),
Pin jack x 1 system
P_B, P_R output (blue, red), 0.7Vp-p (75Ω),
Pin jack x 1 system each

■ Analog audio output

2.0V (rms), 2.2kΩ or below, pin jack
(L, R) x 1 system
2.0V (rms), 2.2kΩ or below, pin jack x 6

■ Digital audio output (OPTICAL/COAXIAL jack)

Optical connector x 1 system
Coaxial pin jack x 1 system, 0.5Vp-p (75Ω)

■ ETHERNET port

100BASE-TX/10BASE-T x 1

■ EXTENSION port

2 systems

■ RS-232C connector

DSUB 9 pin

■ HDMI output

19 pin, Type A connector

■ Remote control

Wireless remote control (RC-715DV)

■ Operating conditions

Temperature: 41°F ~ 95°F (5°C ~ 35°C)
Position: Horizontal

■ Clock accuracy

Quartz (monthly deviation: approximately ±30 seconds)

- Designs and specifications are subject to change without notice.
- This model may not be compatible with features and/or specifications that may be added in the future.
- The illustrations and screens described in this manual may be exaggerated or simplified for easy recognition and may be slightly different from the actual unit.

ONKYO CORPORATION

Sales & Product Planning Div. : 2-1, Nisshin-cho, Neyagawa-shi, OSAKA 572-8540, JAPAN
Tel: 072-831-8023 Fax: 072-831-8124

ONKYO U.S.A. CORPORATION

18 Park Way, Upper Saddle River, N.J. 07458, U.S.A.
Tel: 201-785-2600 Fax: 201-785-2650 <http://www.us.onkyo.com/>

ONKYO EUROPE ELECTRONICS GmbH

Liegnitzerstrasse 6, 82194 Groebenzell, GERMANY
Tel: +49-8142-4401-0 Fax: +49-8142-4401-555 <http://www.eu.onkyo.com/>

ONKYO EUROPE UK Office

Suite 1, Gregories Court, Gregories Road, Beaconsfield, Buckinghamshire, HP9 1HQ
UNITED KINGDOM Tel: +44-(0)1494-681515 Fax: +44(0)-1494-680452

ONKYO CHINA LIMITED

Unit 1&12, 9/F, Ever Gain Plaza Tower 1, 88, Container Port Road, Kwai Chung,
N.T., HONG KONG Tel: 852-2429-3118 Fax: 852-2428-9039
<http://www.ch.onkyo.com/>



Y0710-1



Printed on 70% Recycled Paper

SN 29344614

(C) Copyright 2007 ONKYO CORPORATION Japan. All rights reserved.



* 2 9 3 4 4 6 1 4 *